

VLAAMSE REGULATOR VOOR DE MEDIA

Onafhankelijk toezichthouder voor
de Vlaamse audiovisuele media

ALGEMENE KAMER

MEDEDELING BETREFFENDE DE
CONFORMITEIT VAN HET
KOSTENTOEREKENINGSSYSTEEM VAN
TELENET VOOR HET JAAR 2022

8 juli 2024

Inhoud

1	Voorwerp.....	3
2	Retroacta.....	4
3	Juridische basis	5
4	Vaststellingen van de VRM	6
5	Handtekening.....	7
	Bijlage 1: Conclusie van de bedrijfsrevisor voor 2022.....	8
	Bijlage 2: Beschrijving van het kostentoerekenings-systeem van Telenet voor 2022.....	12

1 Voorwerp

- 1 Met deze mededeling publiceert de VRM, gebaseerd op het controleverslag van de bedrijfsrevisor die hiervoor werd aangesteld, de overeenstemmingsverklaring voor het kostentoerekeningssysteem van Telenet voor het jaar 2022, ter uitvoering van de verplichting tot kostentoerekening van Telenet zoals opgelegd in CRC-beslissing van 29 juni 2018 met betrekking tot de analyse van de markt voor televisieomroep in het Nederlandse taalgebied (verder de CRC-beslissing van 29 juni 2018) en overeenkomstig artikel 192/6, § 4, van het decreet van 27 maart 2009 betreffende radio-omroep en televisie (hierna het Mediadecreet), zoals gewijzigd bij decreet van 2 juli 2021 betreffende de gedeeltelijke omzetting van het Europees Wetboek voor Elektronische Communicatie.¹
- 2 Een kostentoerekeningssysteem (of *'cost accounting system'*) is een geheel van regels aan de hand waarvan de kosten, inkomsten en ingezet kapitaal van een onderneming over haar verschillende diensten en activiteiten kunnen worden verdeeld. Het kostentoerekeningssysteem omvat met name de middelen (processen, basisgegevens, procedures..) waarmee de onderneming de nodige informatie kan registreren om te voldoen aan zijn wettelijke en reglementaire verplichtingen, met name door zijn inkomsten, kosten, activa en kapitaal blijvend te traceren. Het kostentoerekeningssysteem moet de regulator in staat stellen om over informatie te beschikken over de kosten van de diensten die aan regulering onderworpen zijn, en op die basis te bepalen of een operator zijn wettelijke en reglementaire verplichtingen is nagekomen.

¹ Decreet van 2 juli 2021 tot wijziging van het decreet van 27 maart 2009 betreffende radio-omroep en televisie, wat betreft de gedeeltelijke omzetting van richtlijn (EU) 2018/1972 van het Europees Parlement en de Raad van 11 december 2018 tot vaststelling van het Europees wetboek voor elektronische communicatie, *BS* 14 augustus 2021

2 Retroacta

- 3 Telenet heeft het BIPT de volgende documenten bezorgd:
 - De vertrouwelijke versie van de functionele documentatie op 2 oktober 2023;
 - Het verslag van opdracht van onafhankelijke verzekering van de auditeur (BDO Bedrijfsrevisoren) met betrekking tot het systeem voor kostentoerekening opgesteld door Telenet op 2 november 2023;
 - De openbare versie van de functionele documentatie op 23 januari 2024
- 4 De CRC-beslissing van 29 juni 2018 laat toe om op vlak van revisie een grondige audit in het ene jaar te laten afwisselen met een meer beperkte audit het daaropvolgende jaar. Aangezien Telenet voor de kostentoerekening van 2021 een grondige audit² liet uitvoeren, volstaat de versie waarvan sprake in § 3.
- 5 Deze stukken werden in het kader van de samenwerking tussen regulatoren op 31 mei 2024 door het BIPT gedeeld met de VRM.

² Goedgekeurd door de VRM via Mededeling van 26 juni 2023 betreffende de conformiteit van het kostentoerekeningsstelsel van Telenet voor 2021

3 Juridische basis

- 6 *Artikel 192/6, § 4, van het Mediadecreet schrijft voor dat “§4. De Vlaamse Regulator voor de Media zorgt ervoor dat, als de invoering van een kostentoerekeningssysteem verplicht wordt gesteld met het oog op prijscontrole, een beschrijving van dat systeem voor het publiek beschikbaar wordt gesteld waarin ten minste de hoofdcategorieën waarin de kosten worden ingedeeld, en de regels voor de toerekening van de kosten worden vermeld. De inachtneming van het kostentoerekeningssysteem wordt op kosten van de onderneming geverifieerd door een erkende revisor, die elk jaar een verklaring van overeenstemming opstelt die de Vlaamse Regulator voor de Media publiceert.”*
- 7 In de CRC-beslissing van 29 juni 2018 werd de verplichting aan Telenet opgelegd om een kostentoerekeningssysteem op te zetten. Hierin worden ook de voorwaarden bepaald waaraan Telenet moet voldoen bij de toepassing van zijn kostentoerekeningssysteem. Die voorwaarden hebben betrekking op de algemene principes, de kwaliteit van de informatie, de toerekenings- en evaluatieregels, de documentatie, de beschrijving en de controle van het kostentoerekeningssysteem alsook op de na te leven termijnen

4 Vaststellingen van de VRM

- 8 De VRM heeft nagekeken of de opdracht die Telenet aan de bedrijfsrevisor heeft toevertrouwd, voldeed aan de voorschriften van bijlage F van de CRC-beslissing van 29 juni 2018, namelijk: de relevantie verifiëren van de omtrek van de kosten en inkomsten, de inachtneming van de basisvereisten verifiëren, de toepassing van de toewijzings- en evaluatieregels verifiëren en een verslag overleggen aan de VRM over de uitvoering van zijn opdracht.
- 9 De VRM heeft vastgesteld dat Telenet de uitvoering van de audit had toevertrouwd aan BDO Bedrijfsrevisoren CVBA
- 10 De VRM heeft vastgesteld dat de inhoud van de functionele documentatie en van de openbare beschrijving van het kostentoerekeningssysteem voldeed aan de voorschriften van bijlage F van de CRC-beslissing van 29 juni 2018.
- 11 Een beschrijving van het door Telenet opgezette kostentoerekeningssysteem is opgenomen in bijlage 2
- 12 Overeenkomstig de CRC-beslissing van 29 juni 2018 (bijlage F) moet de bedrijfsrevisor nagaan of de toegepaste toewijzings- en herwaarderingsregels wel beantwoorden aan de documentatie die door Telenet is voorbereid en aan de beschrijving van het kostentoerekeningssysteem.
- 13 Op basis van het controleverslag van de bedrijfsrevisor concludeert de VRM dat het Telenet-kostentoerekeningssysteem voor het jaar 2022 in alle opzichten voldoet aan alle materiele aspecten, aan het wettelijk kader dat werd vastgelegd door het Mediadecreet en de CRC-beslissing van 29 juni 2018.
- 14 De conclusies van de bedrijfsrevisor zijn opgenomen in bijlage 1 bij deze mededeling

5 Handtekening

15 Aldus vastgesteld te Brussel op 8 juli 2024.

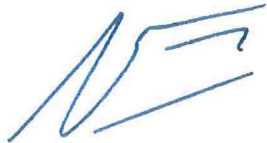
A handwritten signature in blue ink, consisting of several fluid, connected strokes that form a stylized representation of the name 'C. Adams'.

C. ADAMS
Voorzitter

Bijlage 1: Conclusie van de bedrijfsrevisor voor 2022



T +32 (0)2 778 41 00
F +32 (0)2 771 56 56
www.bdo.be

The Corporate Village
Du Vinsilhem 9, box 16
B-1935 Zaventem

Report of factual findings - on Telenet's Wholesale Cost Allocation Report

To the Board of Directors and Management of TELENET

We have performed the procedures agreed with you and enumerated below with respect to Telenet's Wholesale Cost Allocation Report as at October 31, 2023 when our procedures were finalised, set forth in the accompanying schedules. Our engagement was undertaken in accordance with the International Standard on Related Services applicable to agreed-upon procedures engagements. The procedures were performed solely to assist you in evaluating the validity of the mentioned Wholesale cost allocation Report and its compliance to the supporting documentation (Telenet Wholesale cost allocation model) and are summarized as follows:

1. Agreed-upon Procedures related to OPEX

- 1.1. We agreed data extracted from the Telenet central management reporting system (ESSBASE) to audited Financial Statement.
- 1.2. We attended the reperformance of the extraction performed, traced and agreed the result of the extraction to accounting records in Telenet's ERP System (Oracle Fusion) detailed by Responsibility Centers ("RSP").
- 1.3. We reviewed consistency of Responsibility Centers grouping and the rationalization for inclusion or exclusion in Telenet's Wholesale Cost Allocation Report.
- 1.4. We confirmed with appropriate Telenet's responsible the relevance of allocation keys considered at the different steps of the cost allocation.
- 1.5. We recomputed the final output of the defined costs related to OPEX by applying the different steps of the Cost Allocation Model based on the Data Input and the allocation keys.

2. Agreed-upon Procedures related to CAPEX

- 2.1. We traced and agreed initial cost asset value integrated in Telenet's Wholesale Cost Allocation Report to the extraction of the Fixed Assets module in Telenet's ERP System (Oracle Fusion).
- 2.2. We reviewed that relevant controls are designed and reviewed by the SOX team in order to correctly capitalize expenses.
- 2.3. We reviewed that no change occurred regarding the initial book value of the assets and the useful life against assets that were already existing in 2022.
- 2.4. We reviewed that the inflation considered to define the Tilted Annuity Depreciation of assets is aligned to official historic Belgian Consumer Price Index (CPI).
- 2.5. We reviewed that the Weighted Average Cost of Capital ("WACC") considered to define the Tilted Annuity Depreciation of assets is aligned to the Belgian Institute for Postal Services and Telecommunications requirements for cable activities.
- 2.6. We recomputed the Tilted Annuity Depreciation based on the initial book value, the defined useful life, the inflation rates and the Weighted Average Cost of Capital.
- 2.7. We confirmed with appropriate Telenet's responsible the relevance of allocation keys considered at the different steps of the cost allocation.
- 2.8. We recomputed the final output of the defined costs related to CAPEX by applying the different steps of the Cost Allocation Model based on the Data Input and the allocation keys.



T : +32 (0)2 778 01 00
F : +32 (0)2 771 56 56
www.bdo.be

The Corporate Village
Du Vinckham 9, Box 116
B 1935 Zaventem

We report our findings regarding Agreed-upon Procedures on OPEX below:

With respect to item 1.1 We agreed data extracted from the Telenet central management reporting system (ESSBASE) to audited Financial Statement.

We did not find any difference that is not justified by IFRS adjustments.

With respect to item 1.2 We attended the reperformance of the extraction, traced and agreed the result of the extraction to accounting records in Telenet's ERP System (Oracle Fusion) detailed by Responsibility Centers ("RSP").

We did not observe any difference.

With respect to item 1.3 We reviewed consistency of Responsibility Centers grouping and the rationalization for inclusion or exclusion in Telenet's Wholesale Cost Allocation Report.

We did not find any inconsistency.

With respect to item 1.4 We confirmed with appropriate Telenet's responsables the relevance of allocation keys considered at the different steps of the cost allocation.

We did not observe allocation key that were not aligned with Telenet's responsables' confirmation.

With respect to item 1.5 We recomputed the final output of the defined costs related to OPEX by applying the different steps of the Cost Allocation Model based on the Data Input and the allocation keys.

We did not observe any difference.



T : +32 (0)2 778 01 00
F : +32 (0)2 771 56 56
www.bdo.be

The Corporate Village
Du Vrombauw 9, box 16
B-1935 Zaventem

We report our findings regarding Agreed-upon Procedures on CAPEX below:

With respect to item 2.1	<p>We traced and agreed initial cost asset value integrated in Telenet's Wholesale Cost Allocation Report to the extraction of the Fixed Assets module in Telenet's ERP System (Oracle Fusion).</p> <p>We did not find any difference.</p>
With respect to item 2.2	<p>We reviewed that relevant controls are designed and reviewed by the SOX team to correctly capitalized expenses.</p> <p>We did not observe any control design weakness.</p>
With respect to item 2.3	<p>We reviewed that no change occurred regarding the initial book value of the assets and the useful life against assets that were already existing in 2022.</p> <p>We did not find any inconsistency.</p>
With respect to item 2.4	<p>We reviewed that the inflation considered to define the Tilted Annuity Depreciation of assets is aligned to official historic Belgian Consumer Price Index (CPI).</p> <p>We did not observe any deviation.</p>
With respect to item 2.5	<p>We reviewed that the Weighted Average Cost of Capital ("WACC") considered to define the Tilted Annuity Depreciation of assets is aligned to the Belgian Institute for Postal Services and Telecommunications requirements for cable activities.</p> <p>We did not find any inconsistency.</p>
With respect to item 2.6	<p>We recomputed the Tilted Annuity Depreciation based on the initial book value, the defined useful life, the inflation rates and the Weighted Average Cost of Capital.</p> <p>We did not identify any difference.</p>
With respect to item 2.7	<p>We confirmed with appropriate Telenet's responsables the relevance of allocation keys considered at the different steps of the cost allocation.</p> <p>We did not observe allocation key that were not aligned with Telenet's responsables' confirmation.</p>
With respect to item 2.8	<p>We recomputed the final output of the defined costs related to CAPEX by applying the different steps of the Cost Allocation Model based on the Data Input and the allocation keys.</p> <p>We did not observe any difference.</p>



T : +32 (0)2 778 01 00
F : +32 (0)2 771 56 56
www.bdo.be

The Corporate Village
De Vriemilaan 9, Box E6
B-1935 Zaventem

Because the above procedures do not constitute either an audit or a review made in accordance with International Standards on Auditing or International Standards on Review Engagements we do not express any assurance on Telenet's Wholesale Cost Allocation Report as at October 31, 2022 when our procedures were finalised.

Had we performed additional procedures or had we performed an audit or review of the financial statements in accordance with International Standards on Auditing or International Standards on Review Engagements, other matters might have come to our attention that would have been reported to you.

Our report is solely for the purpose set forth in the first paragraph of this report and for your information and is not to be used for any other purpose or to be distributed to any other parties. This report relates only to the accounts and items specified above and does not extend to any financial statements of TELENET BV, taken as a whole.

Zaventem,

Date: 31/10/2023 | 18:21:20 CET

DocuSigned by:
Steven Cauwenberghs
F82E00DF092C4C9

BDO Advisory BV
Represented by Steven Cauwenberghs

Bijlage 2: Beschrijving van het kostentoerekenings-systeem van Telenet voor 2022



Telenet Wholesale Cost Allocation System



Table of contents

1. General description and scope	4
2. Network design	7
2.1. Core Network Fiber	8
2.2. Access Network Fiber	8
2.3. Access Network Coax	8
3. Organisational structure	11
3.1. Network related departments (TIO)	11
3.2. Supporting departments	12
4. Relevant system landscape and data flows	15
4.1. Oracle Fusion (ERP)	16
4.2. Oracle Fusion (HR)	18
4.3. SFR	19
4.4. Data warehouse	20
4.5. Essbase	20
5. Fixed assets (incl. valuation)	23
5.1. Process flow	23
5.2. Asset base	27
5.3. Asset valuation	28
6. Cost allocation model	31
6.1. Cost allocation flow - Opex	32
6.2. Cost allocation flow – CAPEX	45
6.3. Summary of Cost allocation flow	50
7. Control mechanisms	53
7.1. Reconciliation of US GAAP vs IFRS figures	53
7.2. Regular Controls by Liberty Global	54



Chapter 1: General description and scope



1. General description and scope

Telenet is the largest cable television operator in Belgium. Its hybrid fiber-coaxial cable network covers 66% of the national footprint of Belgium based on homes passed. The network spans across the whole of Flanders (two-third owned by Telenet and one-third operated and owned by Fluvius), approximately two-third of the Brussels-Capital Region and some municipalities around Rance in the Walloon area.

Telenet offers basic and enhanced video, including high definition (HD), pay television and video-on-demand (VOD) services, high-speed broadband internet and fixed-line and mobile telephony services to residential subscribers who reside in Telenet's network area.

Over the past few years, Telenet Group was able to expand its services and customer experience by acquiring 1/ BASE company (Q1 2016, customer base of this stand-alone mobile operator and its mobile network) and 2/ SFR Belgium (Q2 2017, extending its services to parts of Brussels region)

In the recent history of the company, Telenet Group made several investments supporting customer experience and enhancing quality, performance and speed of the networks in both Flanders and Brussels area and both fixed and mobile network. Main investments programs over the past years were:

1. Fixed network upgrade with the 'Grote Netwerf' and bring the capacity of the network to 1GHz, which is a five-year investment program started in Q3 2015 for an amount of €500 million.
2. Mobile network upgrade and new build of mobile sites in the 'Radar' program, which was a three-year investment program started in Q3 2016 for an amount of €300 million.
3. Fixed network upgrade and rebuild in Brussels footprint at the back of SFR acquisition, resulting in a one-year investment program of €30 million started in Q4 2017.

The Telenet Business department serves the business market in Belgium with connectivity (video, voice and data services) and value-added services, such as cloud, hosting and security solutions, to SMEs and large-sized businesses.

Telenet has in total more than 3,000 employees, excluding the indirect employment in Belgium for installation and repair activities, customer care services, social projects and product development. Telenet Group is part of Telenet Group Holding NV and is quoted on Euronext Brussel under ticker symbol TNET. Liberty Global, the world's largest international TV and broadband company, owns a direct stake of 58.3% in Telenet Group Holding SA/NV (excluding any treasury shares held by the latter from time to time).

As of 2019, the Belgisch Instituut voor Postdiensten en Telecommunicatie (BIPT) requests network service providers, which might have a strong market position, to provide on an annual basis, financial information (including Profit & Loss financial statements, Fixed Assets and Depreciations) and process documentation related to data flows and implemented control mechanisms. This data needs to be provided for all the company assets and areas, which are in scope of the fixed Coax network regulation.

According to Article 62, §4 of the law from 13 June 2005 referring to electronic communication and article 51, § 4 of the law from 5 May 2017 the BIPT requires an audit of the established cost allocation systems by an external audit company. The conclusions of this audit report will be used by the BIPT to publish every year a statement on the consideration of the cost allocation system.

This documentation serves the purpose to 1/ describe the cost allocation methodology Telenet is currently applying and 2/ providing further information on current cost structures towards BIPT. The handbook can be used as a basis for the mandatory external audit to assess the current cost allocation methodology and data flows applied by Telenet.



The document contains the following chapters:

- Chapter 1: serves as an introduction, providing more background on the scope of the document.
- Chapter 2: provides an overview of the Telenet network design in scope of regulation.
- Chapter 3: describes the organisation of Telenet and indicates the business departments in scope of regulatory requirements.
- Chapter 4: explains the underlying financial data flows and source systems towards the cost allocation model.
- Chapter 5: elaborates on the determination of the assets base as well as valuation and depreciation methodologies applied.
- Chapter 6: deals with the entire cost allocation flow starting from the relevant cost base and describing allocation activities applied towards the Technical products.
- Chapter 7: describes the control mechanisms in place to ensure a correct cost base for the allocation model.



Chapter 2: Network design

2. Network design

The wholesale business of Telenet consists of other telecommunication providers using the HFC network of Telenet. These wholesale customers pay a fee for access to the network but offer their own commercial products to their customer base.

The purpose of this chapter is to:

1. Share insights in the build-up and design of the network in scope of regulation.
2. Describe the technical characteristics of the network in scope since these characteristics are used as allocation keys towards technical products.

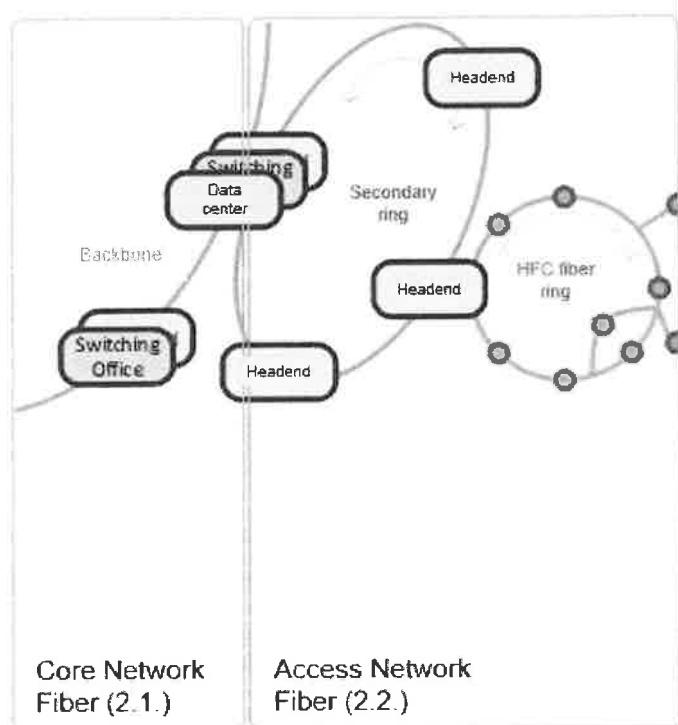

Figure 1: Telenet HFC Network architecture (Source: Telenet Engineering)

The Hybrid Fiber Coax (HFC) network architecture of Telenet, displayed on the figure above, is built on a tree and branch structure where signals are transmitted via both fiber and coax cables throughout the network. The length of the coax cables equals 54,432km, while the fiber network consists of 12,340km fiber cables. The HFC network is a mix of the owned network by Telenet and the network controlled and maintained by Fluvius (former Interkabel). The network is up- and downstream capable, hence interactive services are possible. The sections below describe the design of both Core (2.1.) and Access (2.2. and 2.3.) networks, which form the two main building blocks of the cost allocation model. It is important to understand that Telenet operates, next to the HFC network, also a mobile network, which is not displayed in figure 1 above and out of the scope of this report. The report also only captures the Belgian footprint and abstracts from the installed network in Luxembourg (as these network costs were only applicable up to March 2020).



2.1. Core Network Fiber

The Core network consists out of data centres linked to the backbone of the network that support the connection with the external network (i.e. world wide web). A data centre is a facility that centralises and stores the data flowing within the net. Costs related to this part of the network can be directly linked to the Responsibility Centre Core Network and Operations (Core), which is in scope of the cost allocation model. A full overview of the Responsibility centres is provided in section 6.1.3.

2.2. Access Network Fiber

The active components for both Internet, fixed telephone and television (analogue and digital) are located in the headend locations. These headends are master facilities for receiving and transmitting signals for the processing and distribution of a cable system. Telenet currently possesses 51 headends, including the ones from the SFR acquisition (Brussels and Rance in the region Mons).

The headend facilities are connected to the secondary ring while supporting appliances are typically held in a data centre. As indicated in the figure above, one or multiple fiber rings flow out of a headend. These fiber rings differ from the secondary rings and backbone concerning the technology that runs through the cables. The HFC fiber rings are installed by the TIO network Build & Field services department within a geographic area, ensuring that all segments in this region are covered with signals.

Optical nodes, located on these fiber loops, guarantee that signals can be translated from fiber into coax or from optical into electrical, in both down- and upstream directions. Telenet's network consists out of roughly 7000 of these optical nodes. Telenet Fixed access Engineering has designed the HFC fiber rings in a circular way to create redundancy to cover situations where a breach within the rings would occur. Sometimes, they are connected to an offshoot, which is called an antenna.

2.3. Access Network Coax

The Coax segment further consists out of trunk and distribution sections. Passive components within the network, such as cables, splitters and outdoor taps will attenuate the strength of the signal, while active components or amplifiers provide a boost to the signal. Trunk amplifiers are connected to trunk coax cables which are typically causing less attenuation compared to distribution cables and can, therefore, cover a greater distance. The distribution section covers the further delivery of the signal to the customers.

The distribution part is foreseen with outdoor taps, these can be installed after or in-between amplifiers. These devices are used to connect clients to the network via drop cable lines. Drop cable lines run from an outdoor tap to the end customer or subscriber and receive signals from the HFC network.

At the home of a subscriber, the drop cable is connected to the Network Interface Unit (NIU) by the Field Operations unit. An NIU is a device that serves as a common interface for devices connected with coax within a customer's home or as a link to an outside network without losing signal strength. The NIU has an interactive port for a cable modem (CM) and downstream only ports for a Set-Top Box (STB) or TV.

The average capacity used within the network is monitored continuously by Telenet, which means that the company can intervene if capacity needs to be updated. When launching new products, Engineering first needs to assess what the impact will be on the existing capacity. In the case more capacity would be required, node segmentation can be requested, which means that an additional node will be installed to better serve the network. These instalments are done by the Network Operations unit.

After initial investments to install the necessary capacity, example given node segmentation or frequency expansion, the main costs related to the network design model are maintenance activities as every part of



the network (e.g. amplifier, outdoor taps, headends) needs to stay operational. New Capex investments would be needed in case of system upgrade/expansion or investment in new technologies.

Network spectrum

The network spectrum is an important characteristic of the Telenet Coax network and is configured on a continuous base to serve the different technical offerings. The spectrum usage is applied as an allocation key to allocate Coax related costs to Technical products. The allocation keys are described in chapter 6.

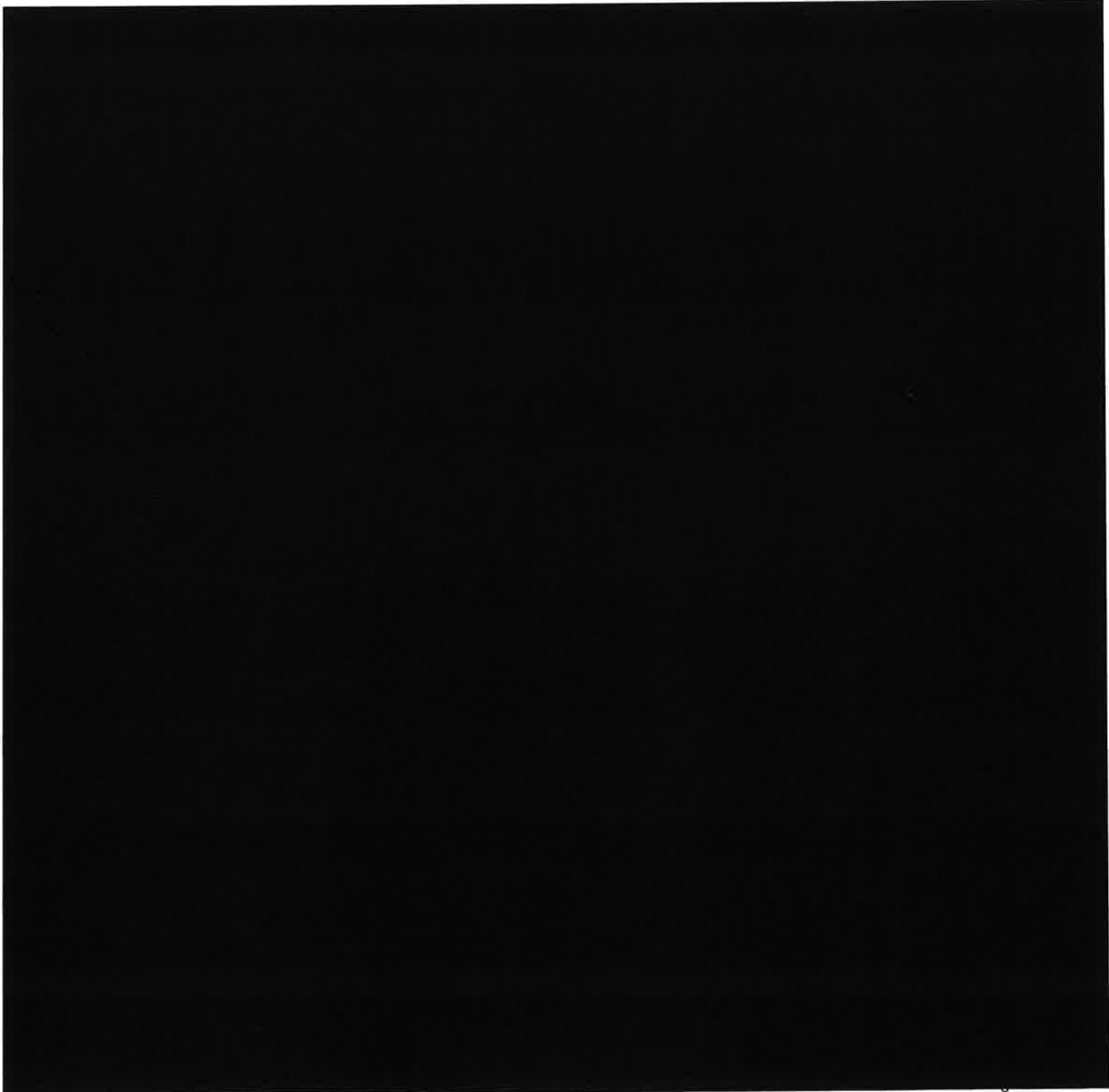



Chapter 3: Organisational structure

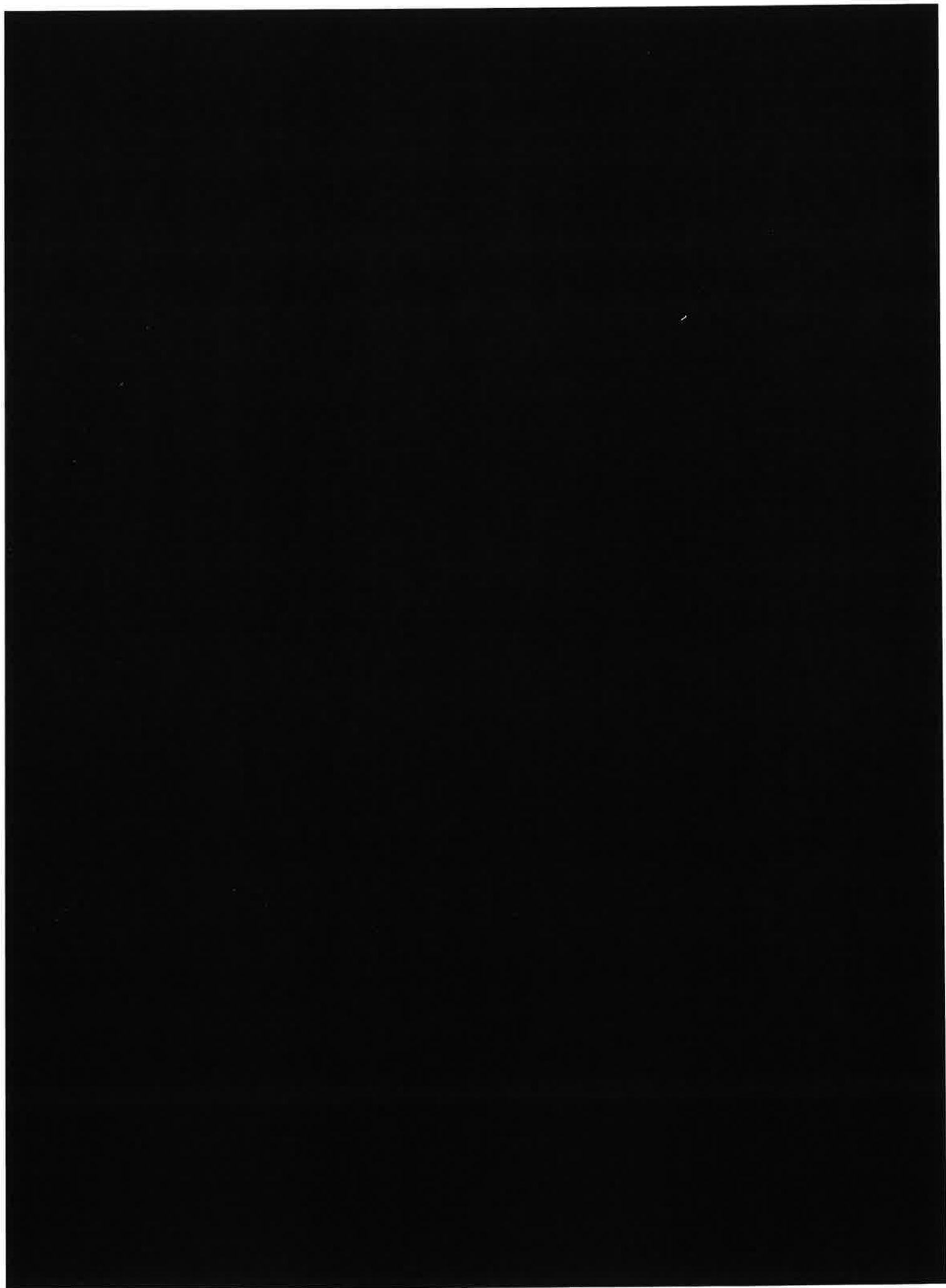

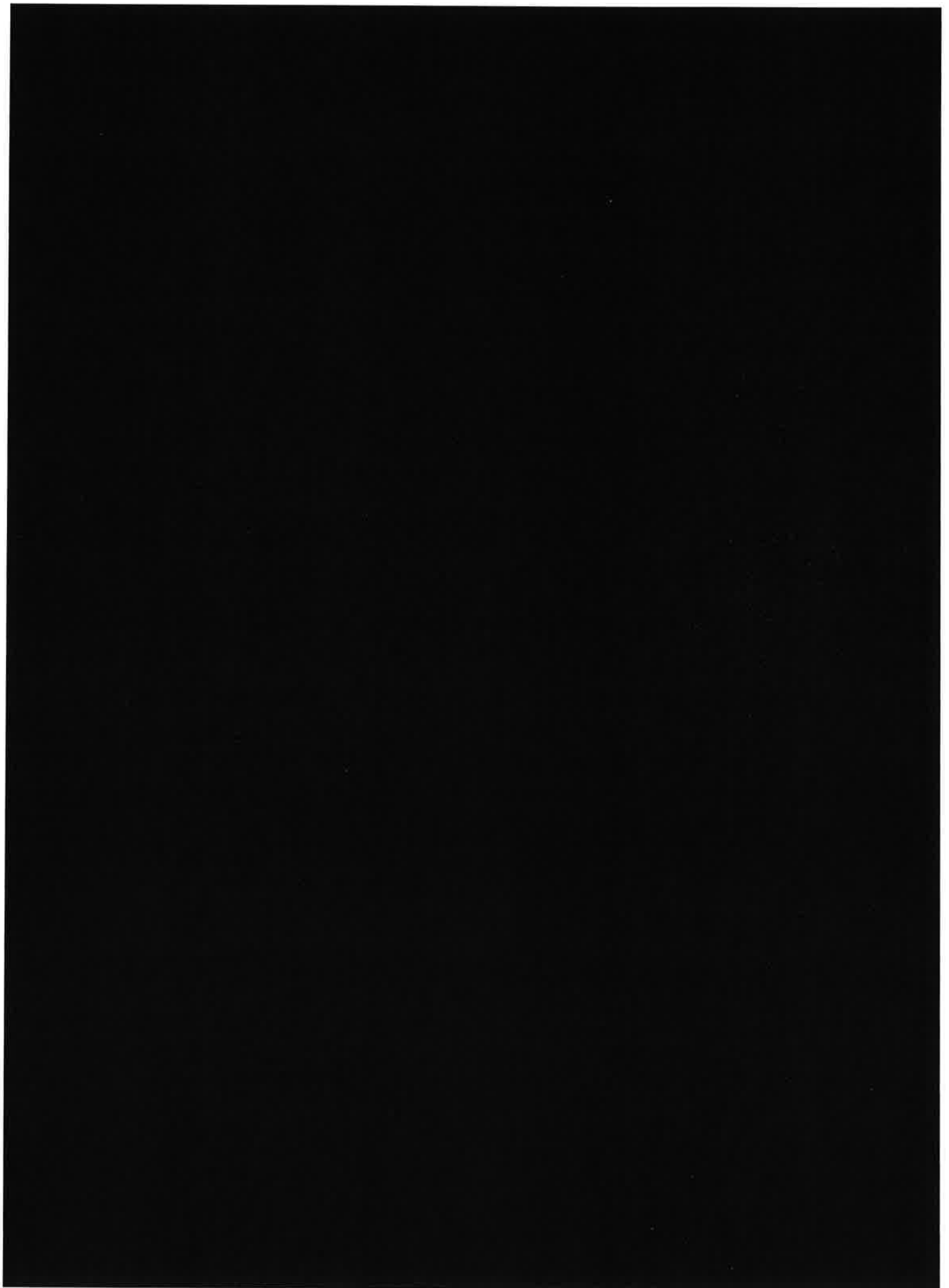

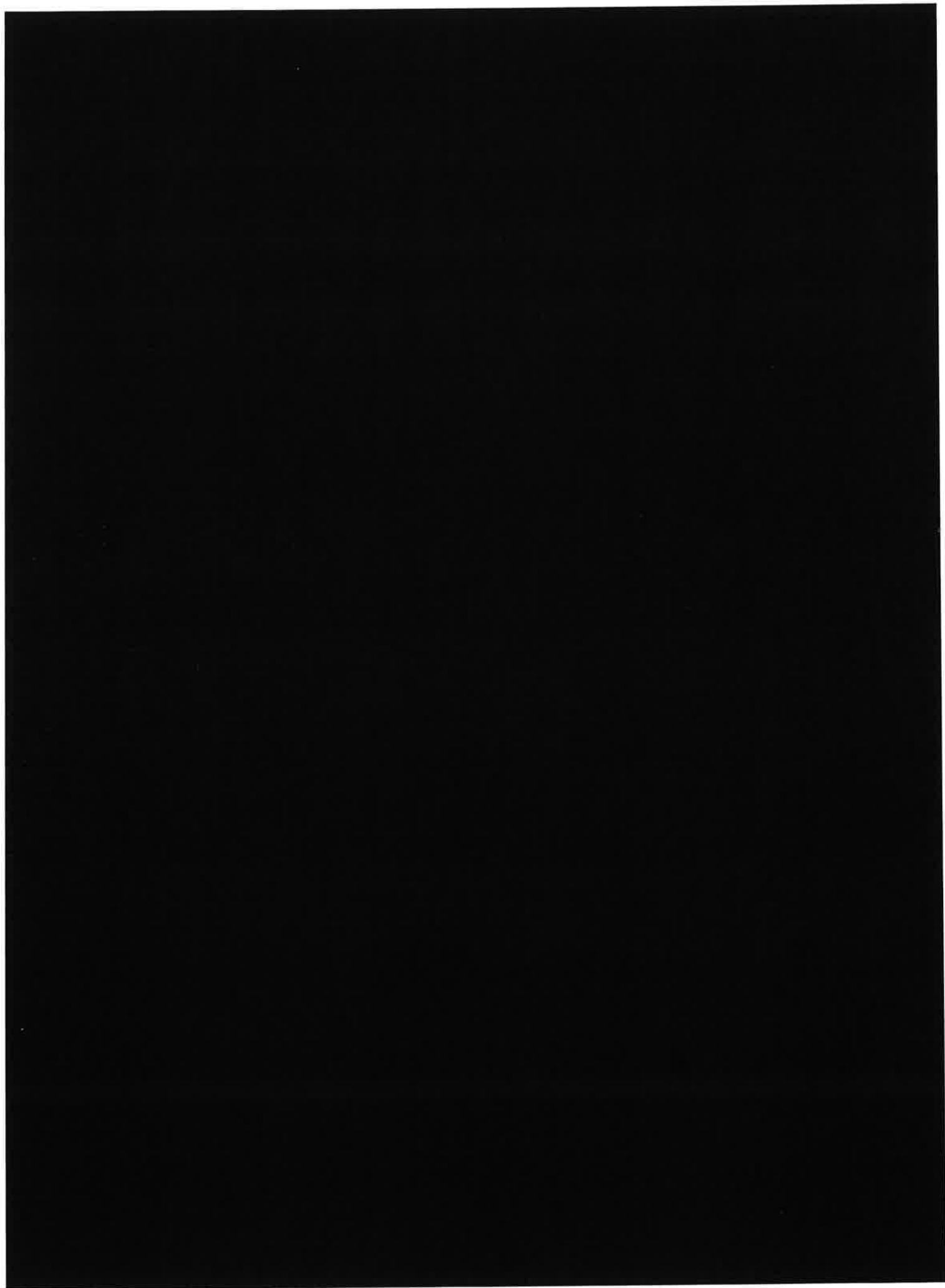



Chapter 4: Relevant system landscape and data flows



4. Relevant system landscape and data flows

The following chapter describes the high-level financial system landscape at Telenet. These systems form the source for all cost data used in the cost allocation model. It is important to provide an overview of how the different data sources flow into the reporting database, called Essbase. By doing so, all relevant information for the cost allocation model - General ledger accounts, Telenet Cost- and Responsibility centres and other operational information - are stored in the Essbase database, which is the source system for the cost allocation model.

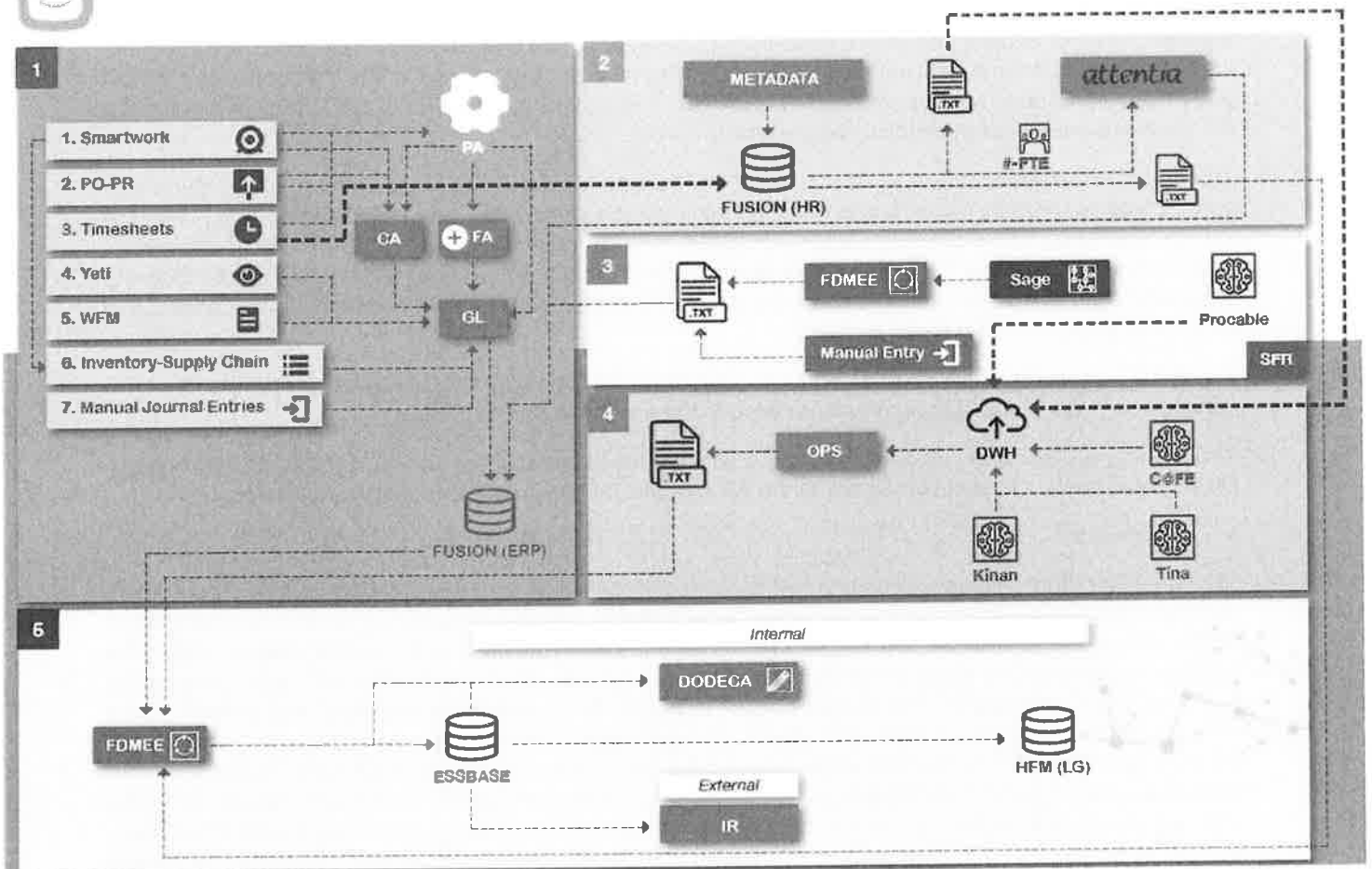

Figure 5: Financial Systems landscape (source: Telenet)

The financial systems landscape of Telenet is centred on Oracle Fusion, which is the main Enterprise Resource Planning tool, including all relevant financial data. There are several modules and ways to input data into Oracle Fusion and four main output modules dealing with management and external reporting. The system landscape can be divided into five main data flows, which are documented in the following sections and visible in the figure above. The data flows 1-4 are input for the Essbase database mentioned in data flow 5.



4.1. Oracle Fusion (ERP)

As indicated in the figure above, seven pillars form the base of the information that flows into the General ledger (G/L) and are subsequently transferred to the Oracle Fusion ERP system: the Procurement module (PO/PR), Smartwork, Timesheets, Yeti, Workforce Management (WFM), Inventory – Supply Chain and Manual Journal Entries.

Further details on the input models, sending data to Oracle Fusion, are described below:

- **PO/PR**

This pillar represents the procurement model of Telenet, handling Purchase Orders (PO) and Purchase Requisitions (PR). After a Purchase Requisition is approved, a Purchase Order is created and sent to the supplier. The PO already contains a classification between Opex and Capex. When goods are received, an accrual is posted and sent into the Cost Accounting module (CA) as well as the Project Module (PA) if any project information was specified on the PR/PO. The cost of the receipts of the POs is booked in the G/L accounts with a corresponding Responsibility centre.

The period-end accruals and accruals@receipt flow further into the Project Module (PA), which gathers all data related to Telenet projects and is mainly used for budget control and capitalisation flows. The PA module combines both Opex and Capex information on project level. For every PO/PR, there is a project and Responsibility centre that can be directly attributed having a one-to-one relationship. Capex POs are handled in the PA module and posted depending on the project status as either assets under construction or fixed assets in the fixed Asset register.

The PO/PR modules allow Telenet to trace costs back to their origin. POs directly related to the HFC network, both Opex and Capex, are considered in the cost base of the model.

The AR and AP modules are dealing with the accounts receivable and account payables of Telenet, e.g. revenue information is sent by Keenan to the AR module in order to register the revenue in Oracle Fusion.

- **Smartwork**

The Smartwork tool is used for construction projects mainly involving external contractors and is a system outside of the Fusion environment. All construction works to the HFC network are part of the cost base in scope. Therefore, Smartwork data entries need to be included in the base of the cost allocation model. The external contractors are flagging the work conducted with a specific Field Service item (FSI) code, which indicates Opex and Capex. The project budget is based on an estimated workload and booked with a manual accrual. During the construction phase, there will be an invoice sent towards the contractors based on the work conducted on the FSI code. After consent by the contractor, the Opex and Capex costs are assigned to a project in the PA module. Opex costs are posted directly to the General ledger, while the capitalisation run takes place in the FA module for Capex FSI codes. There is also a link towards the Oracle Fusion inventory module. Within Smartwork, material usage is registered and transferred to Oracle inventory which can be attributed to a project. After this step, it follows the same flow as direct registration of various transactions within Oracle Fusion inventory.

Both material usage and material maintenance are considered as supporting costs towards the network and need to be included when determining the relevant cost base.

- **Timesheets**

Timesheets are used for input of costs related to internal employees and consultants. Internal employees send a timesheet with performed hours and project/task to the HR-department once management has approved. This data is registered within the PA module with a corresponding Responsibility centre.



Consultants register the performed hours also in timesheets including the hourly rate, for which a cost PO is created. For example, the payroll costs of the network engineers and other people involved in Telenet's wholesale activities are assigned to the cost base of the model. Further information regarding HR data flow is described in section 4.2.

- **Yeti**

Yeti is a module which captures recurring services/fees, e.g. from leased lines. The module is mainly created to control invoices from suppliers or other licensed operators instead of creating data entries. A manual accrual and deferral journal is created based on the install base and newly leased services. These costs can be NRC or RC. Telenet leases part of its network from Fluvius, former Interkabel. These costs are considered in scope of the network regulation and are stored in Yeti before sending them to Oracle Fusion.

- **WFM**

The Workforce management (WFM) module is used to record all materials used by technicians. Materials, used to maintain the Telenet Access & Core Network, are directly related to the wholesale activities and need to be included to ensure a complete and transparent cost base.

- **Inventory/Supply chain**

The Supply Chain application set of Oracle Fusion consists of several modules. The Oracle inventory module is used to track all material purchases in each line of business and stage of the inventory lifecycle. In order to recognise costs related to supply chain, every PO is briefed into projects (or directly on other accounts, e.g. COGS) and costs by the Supply Chain department. Project-related parts of the PO are gathered in the PA module classified into Opex and Capex. The Order management module is used for the picking and shipping of products. It consists of sales order flows and internal order flows. Sales orders (Receivable, Tax and Revenue Part) are recognised in the accounts receivables and posted to the General ledger. Based on the revenue recognition within Receivables, the same percentage is recognised as costs in Cost Accounting. Internal orders can be either a transfer to other locations or issued on a project. The transferred products are debriefed into WFM, Depot and other usage modules. They are linked with project information into the Inventory module (INV). The Inventory module is interfaced to the Cost Accounting module, and changes in inventory (sales/transfer) are integrated into the standard flow of postings in the PA module and G/L accounts.

Supply Chain costs related to transportation or storage of HFC network components are part of the support cost allocation towards the Technical products described in section 6.1.6.

- **Manual journal entries**

The general accounting rule followed by Telenet is to account the cost by the source or its origin. However, there are some exceptional postings, which need a manual journal entry into the General ledger, e.g. the reclassification of the Interkabel assets from assets under construction into fixed assets. This is an important manual correction as it has a direct impact on the cost allocation model, and the magnitude of change in the depreciation account is high. Chapter 5 will further elaborate on the fixed assets ledger, the applicable depreciation actions and describe the Interkabel assets in detail.

There are additional Oracle Fusion modules, which process data and ensure accurate revenue, cost and asset recognition in the General ledger. The relevant modules for the cost allocation system are the following:

- **Project module (PA)**



The project module gathers all project information that is mainly used for budgeting purposes and capitalisation of costs. Further details on the PA module are described in section 5.1 of this document.

- **Fixed assets (FA):**

The Fixed Assets module is part of Oracle Fusion. Once a project has been created in the PA module, new assets can be attributed to a specific project. All amounts that are classified as Capex will be transferred to the FA module including a status information. This status information will define the classification into assets registered and assets under construction. Once the assets are registered, the depreciation will be posted to the General ledger both in P&L and accumulated in the Balance Sheet.

This module plays an important role within the cost allocation model as it is the main data source summarising all fixed asset costs. Thus, the Fixed Assets module is the starting point for the asset cost allocation. Section 5.1 explains the processes applied in the FA module to obtain an accurate cost base.

4.2. Oracle Fusion (HR)

Payroll costs are a large part of the total indirect cost base. People costs related to maintenance, designing or operating of the HFC network are part of the cost base and included in the cost allocation model. The HR Payroll flow can be classified into three different flows related to internal employees, consultants and temporary workforce:

- **Internal employees**

Every new vacancy within the company is created in the Connect system. A Business Controller registers the internal approval of a new vacancy, the budget, the department and the corresponding Responsibility centre within the system. When a person signs a contract at Telenet, the HR department will introduce all personal information in the IT system Connect (Fusion HR).

Every department, as introduced in chapter 3, is linked to an individual Responsibility centre on a one-to-one relation based on a mapping table, e.g. a person working in the HR Department will be allocated to the Responsibility centre HR. The scope of the wholesale allocation model can be determined by extracting the costs of the relevant Telenet Responsibility centres and mapping them towards Responsibility centres using the Liberty Global structure. Section 6.1.4 further elaborates on the Responsibility centres in scope.

In order to check the correct allocation of persons to Responsibility centres, every 15th/16th of a month, an extract from Connect is generated and sent to Business Controlling for review and potential adaptation. The responsible Business Controller provides feedback to the HR department in case of any changes on the Responsibility centres. The HR department will then reload the corrected information back into the Connect database.

By the 25th of the month, all employees should have entered their absences into DOTS, which is the tool used by Attentia. After this process, Attentia, the HR service partner of Telenet, receives the employee data automatically out of the Connect platform on a monthly basis. Attentia will provide a detailed extract of all required information related to the end-of-month payments, the actual payroll cost per employee and Responsibility centres on working day -2/-3 during monthly closing to the HR department. The HR department is adding the Full Time Equivalents (FTE) numbers in that extract and provides the file to the Payroll Accountant and the Reporting team.

Subsequently, the Reporting team loads the FTE data per Responsibility centre in Essbase, reporting tool that will be further discussed in section 4.5, and a Telenet Payroll accountant loads manually these Attentia files, one amount per Responsibility centre, into Fusion (ERP) including accruals, which are calculated manually by a Telenet Payroll Accountant (e.g. holiday provision).



Once the information has been sent into Fusion (ERP), the Capex Accountant is running a capitalisation process in Fusion (ERP) to calculate and book the capitalised labour on the project. This process is only applied for Responsibility centres, which are capitalised via a fixed %-rate based on activities per Responsibility centre, which is calculated by Business Controlling per project code and Responsibility centre. For employees introducing timesheets in Fusion, the Business Controller, based on the payroll average provided by the Payroll Accountant and introduced on the project in Fusion by a Fusion expert, calculates an hourly rate.

Finally, Business Controlling is reviewing the payroll cost including capitalisation per Responsibility centre and checks deviations, e.g. against forecast and budget in Essbase. If errors are found, the necessary corrections are made. The total payroll is divided by the number of FTEs to calculate an average cost per FTE per Responsibility centre.

Once a year a check is done by Telenet, whether Liberty Global introduced new G/L accounts or changed capitalisation rules for the payroll components. Payroll cost components, which can be capitalised, are attributed to the Cap Labour Tree in Fusion in order to calculate the respective depreciation.

- **Consultants**

Consultants need to submit their timesheets on a monthly basis. A Telenet Business Controller will register an hourly rate per consultant. Once a consultant indicates a project he is working on, the hours will automatically be multiplied by the provided hourly rate. This information flows directly into the Fusion (ERP) system via an upload file.

- **Temporary employees**

Telenet receives an invoice for every person working on a temporary basis. Telenet works together with an external Temp Labour Office, which is checking the performed work to see if timesheets entered are correct and match with the invoice. The costs for both consultants and temporary employees are considered as staff-related costs in the cost base. If their projects or tasks comprise network-related activities, these costs are in scope of the cost allocation model.

4.3. SFR

Telenet acquired SFR in 2017 and as part of the integration process offered every SFR customer a new Telenet contract. End of March 2019 all SFR customers were either migrated to Telenet or moved to another telecommunication provider leaving SFR with no operational business activities. However, Telenet made a full upgrade of the SFR network before migrating the existing SFR customers to the new and better performing network. The SFR assets are incorporated into the Fixed Asset register of Telenet increasing the depreciation costs of Telenet after the acquisition and thus the cost base for the asset cost allocation.

The remaining SFR Belgium organisation has since merged with Telenet BVBA. After migrating the SFR customers to Telenet, the billing system within SFR (Procable) became obsolete. In the past, Procable sent a daily feed to the Telenet Data warehouse (DWH) system, ensuring all customer-related information was stored in one system. Costs related to SFR Luxembourg (Coditel Sarl) are excluded from this exercise and Coditel Sarl has merged with Eltrona as of April 1st, 2020.

As a result of the merger of the SFR Belgium organisation within Telenet bvba the SFR accounting system 'SAGE' became obsolete in the course of 2020.

The network of SFR is in scope of the Coax network regulation and, therefore, the costs need to be included in the cost base of the allocation model.



4.4. Data warehouse

The fourth pillar of the financial system landscape is centred on Business Intelligence and Data Warehouse (DWH). The main focus of the DWH environment is to gather and analyse customer and product data. However, there are also other operational data stored e.g. procurement, supply chain and project data. This data is used to define relevant cost allocation keys within the cost allocation model. For example, the number of Revenue Generating Units (RGU) is used in the allocation keys. The customer data flowing into the Data Warehouse environment is sourced out of multiple integrated Telenet CRM systems such as:

- C@fe: is the order registration platform for customers and contains all the information related to customer relationship agreements, including wholesale. Small Office Home Offices (SOHO) are businesses with less than four employees and also registered within the C@fe context.
- Tina: is a platform containing all the Business to Business arrangements and data.
- Kenan/Netcracker: are the central billing system and provides data to operations (DWH) and also to the Finance department for revenue recognition in the General ledger. Every single invoice item is integrated into the Kenan/Netcracker CRM systems.

As stated in the financial systems landscape figure 5, the OPS (Operations) module is a datamart of the DWH section and is created for steering of the operational business. Within the DWH system, multiple types of operational data are subtracted, analysed and modified and afterwards sent via Oracle FDMEE to Essbase, the central management reporting system of Telenet. Examples are: product sales volumes and Revenue Generating Units (RGU) data. The operational data used as Allocation keys are described in section 6.1.6.

4.5. Essbase

Essbase is the Telenet central management reporting system and source system for the cost allocation model. It consists of the following five cubes:

- P&L
- Balance Sheet Fixed Assets (end balances)
- Capex
- Operations
- FTE

General ledger data flows into the Fusion system via the G/L module, as described in section 4.1. This information is mapped to Essbase via the Oracle Financial Data Quality Management Enterprise Edition (FDMEE) mapping tool. FDMEE is the key application for integrating ERP systems with Oracle's EPM applications and is used as main data transfer method in Telenet's financial reporting flow.

Asset data is sourced out of the Fixed Assets (FA) application, while the operational data flows into Essbase via the Data Warehouse hub. The FTE information is sent by Attentia and Connect (Fusion HR) and is mapped via FDMEE to Essbase.

During the monthly closing process, the financial data is uploaded from Oracle Fusion to the HFM reporting system of Liberty Global. The data upload is performed using a predefined mapping table. This mapping table, also called workbench file, is the basis for the internal controls checks described in section 7.2. The internal controls ensure the correct mapping between the Telenet Responsibility centres and Liberty Global Responsibility centres described in section 6.1.3.



Essbase contains all relevant financial and operational information, delivered by Oracle Fusion and other source systems, used for management reporting within Telenet. Essbase contains all the data that is published in the Capital Allocation Report (CAR), used for Liberty Global Reporting purposes. This CAR report has an important role in the cost allocation model as it the base for the allocation of support costs.

As stated in figure 5, Essbase is the source system for HFM, which is the Liberty Global (LG) reporting system. Due to different organisational structures of both Telenet and Liberty Global, the data input from Essbase needs to be mapped towards the Liberty Global reporting framework, e.g. in terms of Responsibility centre structures.



Chapter 5: Fixed assets (incl. valuation)



5. Fixed assets (incl. valuation)

The HFC Network described in chapter 2 contains several asset components, which need to be accounted for. The following chapter describes the Fixed Asset base of Telenet including applied valuation methods. The chapter is important to understand the different asset elements as well as their valuation and processes since this will be the base data for the asset cost allocation to the Technical products in Chapter 6.2.

5.1. Process flow

This section deals with the process to create an asset and the various input sources in the Oracle project module (PA). Section 5.1.2 describes how the relevant asset information for the cost allocation is derived.

5.1.1. Processes in the Oracle Project module (PA)

The Capex process flow starts with the creation of a project template by the Capex Controller. This project template includes various characteristics of the project, e.g. Opex and Capex tasks or Responsibility centre. The Financial Controller is responsible for assigning the correct Asset categories to the project template and afterwards submits the project template to the Oracle project module (PA). The final step of the project template creation is the approval of the Capex Controller. When the project template is approved, new assets can be registered, which is the starting base for capitalisation of fixed assets and thus the asset cost base of the cost allocation model. The most relevant characteristics for the cost allocation model are the classification of tasks into Capex or Opex and the information related to the depreciation of assets, e.g. useful life as well as asset balance sheet and depreciation accounts. An example of a project template is shown in the table below:

PROJECT NUMBER	PROJECT NAME	DESCRIPTION	PROJECT STATUS	TEMPLATE	TOP_TASK	TASK_NAME	CAPITALIZATION FLAG	PRODUCT_DESC#	ASSET_CATEGORY	ASSET_CAT_DESCR
1002672	Installation TV 199	Template voor TV installaties per segment	Closed	T_MIGRATION		Graven/Bus/Fib/Coax	Y	HFC	23-31-3101	Network - HFC - Coax Cable
1019854	Grip COAX BUILD	template te gebruiken voor gripmatenaal Netaanleg	Execution	T_MIGRATION	CAPEX	Graven/Bus/Fib/Coax	Y	Product other	23-31-3101	Network - HFC - Coax Cable
1019859	Grip INSTALL Other	Template te gebruiken voor gripmatenaal Customer	Execution	T_MIGRATION	CAPEX	Graven/Bus/Fib/Coax	Y	HFC	23-31-3101	Network - HFC - Coax Cable
1020281	Supply Chain general	Template te gebruiken door logistiek voor capex HE	Execution	T_MIGRATION		Install & connect	Y	Product other	23-31-3101	Network - HFC - Coax Cable
1022721	HFC Build Support	Template voor Coax Build projecten	Execution	T_MIGRATION	CAPEX	Graven/Bus/Fib/Coax	Y	Product other	23-31-3101	Network - HFC - Coax Cable
1022721	HFC Build Support	Template voor Coax Build projecten	Execution	T_MIGRATION	CAPEX	PLM-brieven	Y	Product other	23-31-3101	Network - HFC - Coax Cable
1022721	HFC Build Support	Template voor Coax Build projecten	Execution	T_MIGRATION	CAPEX	Externe Projectkost	Y	Product other	23-31-3101	Network - HFC - Coax Cable
1022721	HFC Build Support	Template voor Coax Build projecten	Execution	T_MIGRATION	CAPEX	Interne Planafdruck	Y	Product other	23-31-3101	Network - HFC - Coax Cable
1022721	HFC Build Support	Template voor Coax Build projecten	Execution	T_MIGRATION	CAPEX	Outsourced Labour	Y	Product other	23-31-3101	Network - HFC - Coax Cable
1022721	HFC Build Support	Template voor Coax Build projecten	Execution	T_MIGRATION	CAPEX	Planafdrucken	Y	Product other	23-31-3101	Network - HFC - Coax Cable
1022721	HFC Build Support	Template voor Coax Build projecten	Execution	T_MIGRATION	CAPEX	Verzekeringen	Y	Product other	23-31-3101	Network - HFC - Coax Cable
1022721	HFC Build Support	Template voor Coax Build projecten	Execution	T_MIGRATION	CAPEX	Integr Overz.pl. UPC	Y	Product other	23-31-3101	Network - HFC - Coax Cable
1024202	Cap Labor - HFC Build	Template voor Cap Labor Coax Build	Closed	T_MIGRATION	CAPEX	Coax Build-Build	Y	Product other	23-31-3101	Network - HFC - Coax Cable
1024202	Cap Labor - HFC Build	Template voor Cap Labor Coax Build	Closed	T_MIGRATION	CAPEX	CoaxBuild-DesignEast	Y	Product other	23-31-3101	Network - HFC - Coax Cable
1024202	Cap Labor - HFC Build	Template voor Cap Labor Coax Build	Closed	T_MIGRATION	CAPEX	CoaxBuild-ProjectSup	Y	Product other	23-31-3101	Network - HFC - Coax Cable
1024202	Cap Labor - HFC Build	Template voor Cap Labor Coax Build	Closed	T_MIGRATION	CAPEX	CoaxBuild-East Infra	Y	Product other	23-31-3101	Network - HFC - Coax Cable
1024202	Cap Labor - HFC Build	Template voor Cap Labor Coax Build	Closed	T_MIGRATION	CAPEX	CoaxBuild-DesignWest	Y	Product other	23-31-3101	Network - HFC - Coax Cable
1024202	Cap Labor - HFC Build	Template voor Cap Labor Coax Build	Closed	T_MIGRATION	CAPEX	CoaxBuild-AdminSuppo	Y	Product other	23-31-3101	Network - HFC - Coax Cable
1024202	Cap Labor - HFC Build	Template voor Cap Labor Coax Build	Closed	T_MIGRATION	CAPEX	CoaxBuild-Ext-Servic	Y	Product other	23-31-3101	Network - HFC - Coax Cable
1024203	Cap Labor - HFC Build	Template voor Cap Labor Coax Build	Closed	T_MIGRATION	CAPEX	CoaxBuild-Ext-Servic	Y	Product other	23-31-3101	Network - HFC - Coax Cable
1024203	Cap Labor - HFC Build	Template voor Cap Labor Coax Build	Closed	T_MIGRATION	CAPEX	Coax Build-Build	Y	Product other	23-31-3101	Network - HFC - Coax Cable

Table 1: Example Project template (source: PA module)

There are six different sources for the data entry in the PA module: Purchase Orders (Opex and Capex), Capitalised Labour, Inventory, Smartwork, Accounts Receivable/Payables and manual accruals.

- **Purchase orders**

As described in section 4.1 of this document, purchase orders are created with a defined indication of Opex or Capex and are registered on a respective project. Opex costs will be transferred directly towards the General ledger, while Capex amounts flow to the construction in progress account (CIP). Thus, while Opex costs can be booked directly to the P&L, Capex can only be posted via the project flow described.



At the end of the month, as part of the monthly closing process, a capitalisation run takes place, and new assets are created in the FA module. Every asset is assessed on its execution status and flagged as either 'pending closed and execution' or 'confirmed'. If an asset has the status 'pending closed and execution', it will be created in the Fixed Asset register. Assets with the status 'confirmed' are booked in the Construction in Progress (CIP) account.

The capitalised assets in the Fixed Asset register are registered in the General ledger, and the regular depreciation run is applied, reflecting the depreciation amount in the P&L and respectively in the Balance Sheet. Assets under construction are not depreciated. This is an important difference since only the Fixed Assets are taken into consideration as component of the asset costs in the cost allocation model.

- **Capitalised labour**

Capitalised labour is an integral part of the asset base of the cost allocation model. It requires a more detailed description since the capitalisation rules are shifting costs from Opex to Capex and thus between the different cost allocation flows described in chapter 6.1 and 6.2.

Personnel costs related to investment projects are capitalised on specific Asset categories (e.g. Asset category 23-30-3004 – Network CPE - Cap Labor NIU). There are two different types of capitalisation depending on the direct involvement in the creation of an asset. Internal and external employees building an asset and internal employees working in supporting functions related to assets.

The costs of internal and external employees building an asset are capitalised according to the Capex flow in the PA module. Therefore, timesheets from these employees are gathered. These timesheets include worked hours next to the hourly rates and are assigned to Opex or Capex based on the project tasks indicated in the project template.

The costs of internal employees working in supporting functions are capitalised in a manual process. Payroll Controlling prepares an excel file indicating for every payroll item and Responsibility centre the %-rate of work that can be capitalised. Which payroll item can be capitalised is defined by Liberty Global, while the %-rate of work is prepared by Payroll Controlling based on worked project hours. This process takes place during every monthly closing.

- **Inventory**

The Inventory module collects all material purchases of Telenet. Material items that are related to Capex (e.g. Coax network materials) should be assigned to a project and follow the capitalisation and depreciation flow upon consumption as described above.

- **Other inputs:**

There are also other input flows such as Smartwork, which is described in the data flow section 4.1 and invoices from the Accounts Receivables and Accounts Payables modules. In specific cases, manual journal entries are needed to ensure a complete Asset register, e.g. the monthly manual correction of the Interkabel assets, which is a leasing agreement and an exception to the asset process flow.

Interkabel leasing

Telenet has leased around one-third of its Coax network from Fluvius, formerly Interkabel, based on a long-term lease agreement (Erfpacht). The agreement foresees a quarterly payment of a rental fee to Interkabel consisting of three different components: clientele fee (right for access to clients), annuity fee and canon fee (right to make network improvements). Investments, e.g. new amplifiers, are conducted by Interkabel in their function as network owner. The contract with Interkabel still runs until 2046 and is classified as a



finance lease. However, Telenet also pays an operational fee to Interkabel for maintenance of the network in a separate agreement. The Interkabel Asset categories are ranging from 25-50-5000 to 25-50-5004.

The Interkabel lease agreement is booked manually at the end of every month. The value depends on the agreed budget with Interkabel. The manual posting is necessary because the assets are operationally used but accounting wise still treated as assets under construction. Once posted into the Fixed Asset register, the regular depreciation run starts (IFRS/US GAAP: linear; BE-GAAP: double-declining).

5.1.2. Processes in the Oracle Fusion Assets module (FA)

The following section describes the main actions performed by the Financial Controlling team to manage Fixed Assets. These actions are performed in the Oracle Fusion Assets (FA) module, in which the assets and depreciations registration and handling appear. The processes described, ensure that the input elements for the Capex Cost allocation flow are derived in an accurate and transparent way.

Oracle Fusion Assets (FA) automates asset management and simplifies fixed asset accounting tasks. Using a unified source of asset data, Oracle Assets gives users visibility into the company assets and also provides data security and function access. Standard asset management tasks, such as asset additions, asset transfers, disposals, reclassifications, financial adjustments such as depreciations and legacy data conversions, can be streamlined with automated business flows. Standard accounting, operational, and registry reports are available for ease of reconciliation and analysis.

There are three processes, which are causing changes in the Capex cost base and are thus relevant for the cost allocation model:

- Review/import asset additions
- Perform asset transactions
- Run depreciation

5.1.2.1. Review/import asset additions

The Oracle Fusion Projects module (PA) sends the generated asset lines to Oracle Fusion Assets (FA) as source lines. Source lines help users to track information about where assets came from, including sources such as invoice lines from the accounts payable system and capital assets from Oracle Fusion Projects. A review of the Source Lines from the Feeder System occurs to ensure there is no missing information which would prevent posting. Subsequently, the Post Mass Additions process imports the data into the applicable tables and will create the assets. Once this is registered, the assets will be added to the corporate book and subsequently to Oracle Fusion.

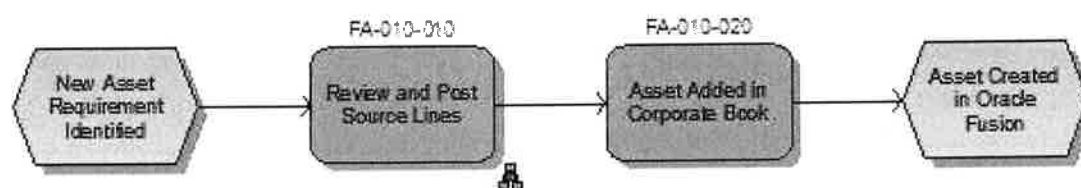

Figure 6: Asset Process FA-010 Review/Import Asset Additions (source: Telenet Processes_v5.xls)



5.1.2.2. Perform asset transactions

When an asset has been created in the Fixed Assets application within the Oracle Fusion environment, there are a number of processes required to ensure that the asset itself is recorded correctly throughout its useful life. These are known as asset adjustments. Processes are also required when an asset reaches the end of its useful life or has been impaired, and the asset needs to be retired.

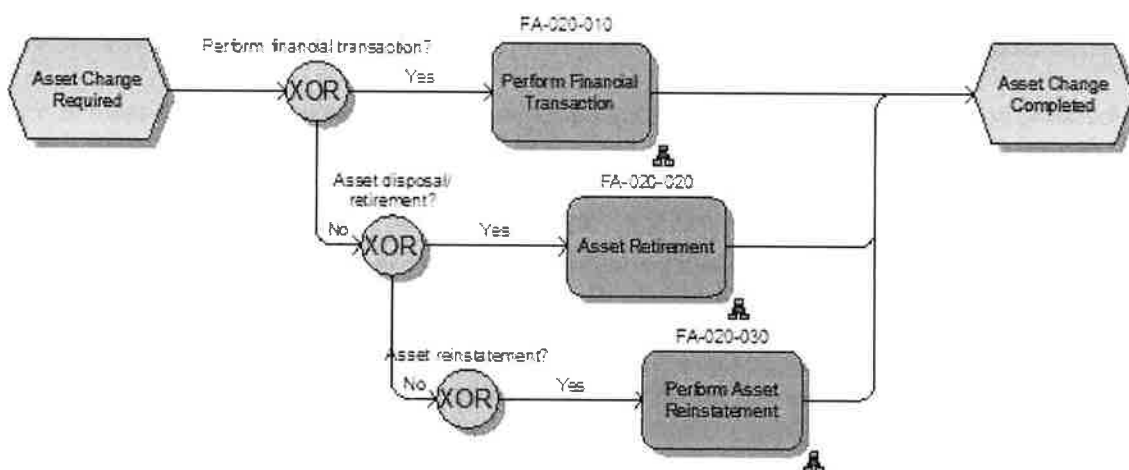

Figure 7: Asset Process FA-020 Perform Asset Transactions (source: Telenet Processes_v5.xls)

The management of the financial implications of fixed assets is a Finance task. The actual management of the physical asset will be owned by the relevant team (e.g. Facilities, IT or Engineering) and will not take place in Oracle Fusion, so adjustments to assets must be reported to the Asset Accounting Manager on a regular basis. If an adjustment is missed, then it will be identified during the Physical Inventory process.

A cost adjustment includes any adjustment that affects the recoverable cost, including a change in cost, salvage value, depreciation, depreciation expense, investment tax credit ceilings, or bonus rules. A user can manually perform a cost adjustment or can automatically perform a cost adjustment by adding a mass addition to an existing asset.

When an asset is no longer in service (stolen, lost, damaged, soled or returned), the asset needs to be retired. The asset can be retired completely, or only a part can be retired when a portion of the asset is no longer in service.

Both transactions, asset additions and asset transactions, can have an impact on the value of the cost allocation model.

5.1.2.3. Calculation of depreciation

The calculate depreciation process needs to be ran to calculate depreciation for all assets in a book for a specific time period. If depreciation is not calculated successfully for any of the assets present in the corporate book, the log file created by Oracle Fusion Assets for the depreciation process will request the status of these assets and the reason why depreciation failed. This is a control to ensure the completeness and correct calculation of the depreciation accounts.

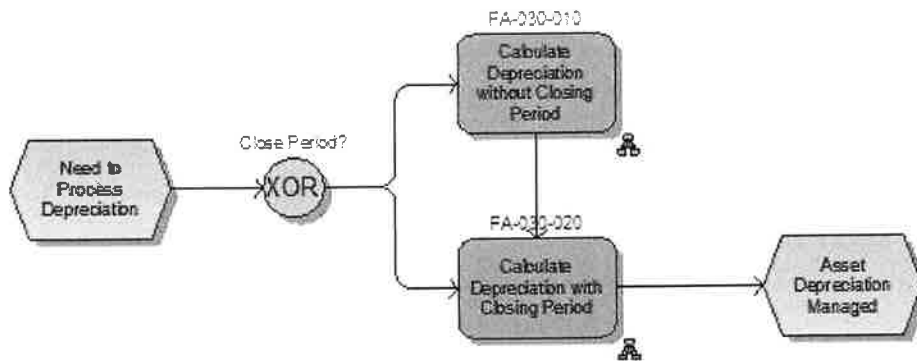

Figure 8: Asset Process FA-030 Run depreciation (source: Telenet Processes_v5.xls)

When a user runs the depreciation, the Fusion Assets module provides the option to close the current financial period automatically after running depreciation. If all of the assets are depreciated successfully, Fusion Assets closes the period and will open the next financial period.

Both options will result in the preparation of the depreciation journals and will be posted to the Fusion General ledger. However, the first depreciation run in each month will generate the full depreciation for all assets, each time when the depreciation is re-run in the same month, only the incremental changes will be calculated and posted.

5.2. Asset base

The Asset base of Telenet consists of different asset components ensuring Telenet’s operational activities and generation of future revenues. The Financial Controlling team of Telenet has defined multiple Asset categories to which assets can be assigned. There are several dimensions, which are attributed to every Asset category. The dimensions that are relevant for the cost allocation method, are the depreciation account, the initial book value of the asset and the useful life. The table below is an extract from the Fixed Asset register and shows these key dimensions, which are indicated in the headline of the table.

Asset_Book	Asset_Category	ASSET_ID	Asset_Number	DESCRIPTION	Life_In_Months	Depreciation_Account	Asset_Cost	YTD_Depr_Amount	Accumulated_Depr_Amount	Net_Book_Value
TELENET US GAAP	23-33-3300	1267132	1267132	Correctie afschr termijn fiber asset 1035182		821800035				
TELENET US GAAP	23-33-3300	1036534	1036534	Coditel		821800035				
TELENET US GAAP	22-21-2101	1034354	1034354	Vanelek		821800003				
TELENET US GAAP	23-33-3300	1036866	1036866	Coditel - faen		821800035				
TELENET US GAAP	23-33-3300	1268861	1268861	Correctie afschr termijn fiber asset 1036911		821800035				
TELENET US GAAP	23-33-3300	1268211	1268211	Correctie afschr termijn fiber asset 1036261		821800035				
TELENET US GAAP	23-33-3300	1035934	1035934	Coditel		821800035				
TELENET US GAAP	23-33-3300	1267386	1267386	Correctie afschr termijn fiber asset 1035436		821800035				
TELENET US GAAP	23-33-3300	1267689	1267689	Correctie afschr termijn fiber asset 1035739		821800035				
TELENET US GAAP	23-33-3300	1035157	1035157	Coditel		821800035				
TELENET US GAAP	23-33-3300	1035167	1035167	Coditel Lux faen		821800035				
TELENET US GAAP	23-33-3300	1036392	1036392	Coditel		821800035				
TELENET US GAAP	23-33-3300	1036836	1036836	Coditel - faca		821800035				
TELENET US GAAP	23-33-3300	1036557	1036557	Coditel		821800035				
TELENET US GAAP	23-33-3300	1267804	1267804	Correctie afschr termijn fiber asset 1035854		821800035				

Table 2: Extract from the Fixed Assets Register (source: FA module, Telenet BVBA)

The highlighted dimensions from the Fixed Asset register are the main input sources for the asset cost allocation and will be further described in section 6.2.1.



5.3. Asset valuation

The next section deals with the valuation methods of the fixed assets, which are following the common IFRS and US GAAP reporting standard guidelines. Asset valuation can have a direct impact on the value of the costs assigned to the cost allocation model.

5.3.1. Asset recognition and revaluation

According to the accounting standard IAS 16 from the IASB, an item of property, plant and equipment is initially measured at its cost. The cost includes:

- The purchase price, including import duties and non-refundable purchase taxes, after deducting trade discounts and rebates.
- Any costs directly attributable to bringing the asset to the location and condition necessary for it to be capable of operating in the manner intended by management.
- The estimated costs of dismantling and removing the item and restoring the site on which it is located, unless those costs relate to inventories produced during that period.

After recognition, an entity chooses either the cost model or the revaluation model as its accounting policy and applies that policy to an entire class of property, plant and equipment.

Under the **cost model**, an item of property, plant and equipment is carried at its cost, less any accumulated depreciation and any accumulated impairment losses.

Under the **revaluation model**, an item of property, plant and equipment whose fair value can be measured reliably is carried at a revalued amount, which is its fair value at the date of the revaluation less any subsequent accumulated depreciation and subsequent accumulated impairment losses. Revaluations must be made regularly and kept current. Revaluation increases are recognised in other comprehensive income and accumulated in equity unless they reverse a previous revaluation decrease. Revaluation decreases are recognised in P&L unless they reverse a previous revaluation increase.

Telenet is using the revaluation method (Current Cost Accounting) for the cost allocation model. This method reflects the development of prices and technologies over the lifetime of an asset. There are different methods to revalue assets under the Current Cost Accounting framework, one being the price indexation method. The price indexation method multiplies the initial book value of an asset with a price index, which is equal to the ratio of the current price to the historical price of the respective asset.

5.3.2. Depreciation method

The Current Cost Accounting framework allows different methods to depreciate an asset. The cost allocation model of Telenet applies the Tilted Annuity Method (TAM) in order to capture price changes during the lifetime of an asset. The TAM method takes into account the economic lifetime of the asset rather than the financial lifetime. The calculation of the Tilted Annuity Method is described in detail in section 6.2.1.

The useful life of an asset is reviewed once a year by Financial Controlling and the Engineering department. The duration is assessed for every Asset category individually and indicated in months. It is part of the project template that forms the base for every new asset registration. The table below shows an extract of the Fixed Asset register, in which every individual asset is assigned with a useful life:



Asset_Book	Asset_Category	ASSET_ID	Asset_Num	DESCRIPTION	Life In Months	Deprn Method Code	Asset Cost Account	Depreciation Expense Account	YTD_Depr_Amount	Net_Book_Value
TELENET US GAAP	23-31-3101	1021474	1021474	TV & HFC 2008		STL	152184007	821800020		
TELENET US GAAP	23-31-3101	1017322	1017322	060-23.31.3101-2000-31		STL	152184007	821800020		
TELENET US GAAP	23-31-3101	1017473	1017473	060-23.31.3101-2000-5		STL	152184007	821800020		
TELENET US GAAP	23-31-3101	1017320	1017320	060-23.31.3101-2000-27		STL	152184007	821800020		
TELENET US GAAP	23-31-3101	1018328	1018328	RG >> D460 2201000.1999 >> ICS : Distributienet		STL	152184007	821800020		
TELENET US GAAP	23-31-3101	1018332	1018332	RG >> D460 2911000.1999 >> ICS : Distributienet		STL	152184007	821800020		
TELENET US GAAP	23-31-3102	1363926	1363926	HFC Electronic Equipment 8j		STL	152184007	821800020		
TELENET US GAAP	23-31-3101	1018357	1018357	RG >> D460 3811000.1999 >> ICS : Distributienet		STL	152184007	821800020		
TELENET US GAAP	23-31-3101	1018660	1018660	RG >> D460 9901000.2003 06 >> TV : Distributienet		STL	152184007	821800020		
TELENET US GAAP	23-31-3102	1330620	1330620	HFC Electronic Equipment 8j		STL	152184007	821800020		
TELENET US GAAP	23-31-3101	1018586	1018586	RG >> D460 5011000.2000 >> ICS : Distributienet		STL	152184007	821800020		
TELENET US GAAP	23-31-3101	1018666	1018666	RG >> D460 9901000.2003 12 >> TV : Distributienet		STL	152184007	821800020		
TELENET US GAAP	23-31-3101	1018430	1018430	RG >> D460 4211000.1999 >> ICS : Distributienet		STL	152184007	821800020		
TELENET US GAAP	23-31-3102	1347396	1347396	HFC Electronic Equipment 8j		STL	152184007	821800020		
TELENET US GAAP	23-31-3101	1017321	1017321	060-23.31.3101-2000-29		STL	152184007	821800020		
TELENET US GAAP	23-31-3101	1018406	1018406	RG >> D460 4111000.1999 >> ICS : Distributienet		STL	152184007	821800020		

Table 3: Extract from the Fixed Assets Register (source: FA module, Telenet BVBA)

5.3.3 Impairment

Impairment of assets can have a strong impact on the P&L and thus on the asset cost base of a period. The core principle in IAS 36 is that an asset must not be carried in the financial statements at more than the highest amount to be recovered through its use or sale. If the carrying amount exceeds the recoverable amount, the asset is described as impaired. The entity must reduce the carrying amount of the asset to its recoverable amount, and recognise an impairment loss. IAS 36 also applies to groups of assets that do not generate cash flows individually (known as cash-generating units).

Telenet conducts impairment tests on its assets quarterly or after triggering events. Since Telenet defined one Revenue Generating Unit (RGU) for impairment testing, all assets in scope are grouped into this single RGU.

However, there are triggering events, in which assets are damaged or lost in value due to new technologies. In these cases, the book value of the asset will be written off.

The G/L accounts for impairments 832200001 and 832100001 are not included in the cost base of the allocation model of Telenet. Thus, impairments of assets have no impact on the cost allocation model.



Chapter 6: Cost allocation model



6. Cost allocation model

This chapter provides an end-to-end view on the structure of the cost allocation model by walking through the major allocation flows and introducing the main building blocks and concepts of the model. The overall purpose of the model is to allocate costs registered in the G/L accounts towards the relevant Technical products, which represent the costs for accessing the HFC network as wholesale customer.

The figure below summarises the complete cost allocation flow. There are two separate cost allocation flows: Opex and Capex. While the Opex flow is described in section 6.1, the Capex flow is described later in section 6.2.

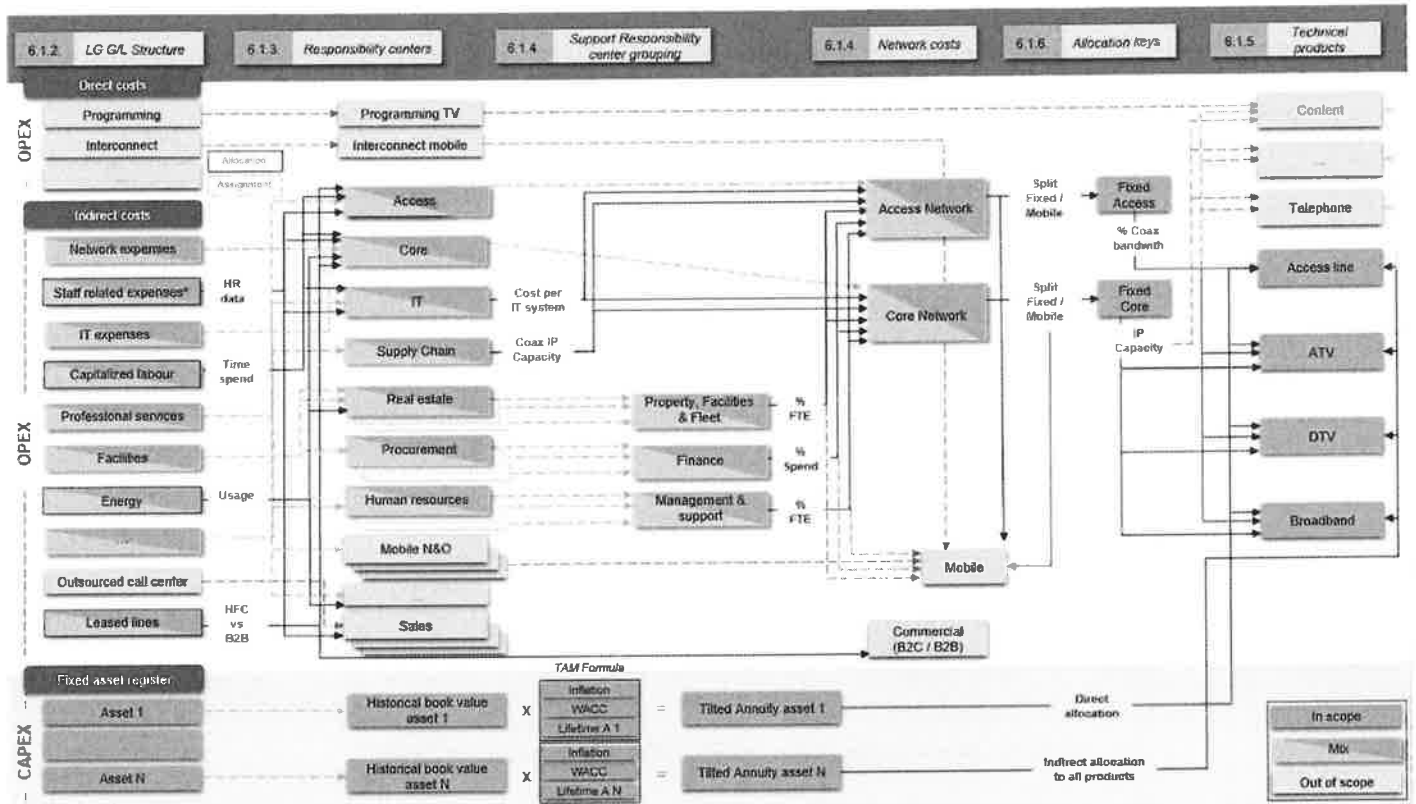

Figure 9: End-to-End Cost allocation flow (Source: created by author)

There are four steps in the Opex cost allocation model starting from left to right:

- 1) Extraction of the full cost base booked in the G/L accounts and defining the G/L accounts in scope of the wholesale business.
- 2) Assignment or allocation of the G/L accounts to functional Responsibility centres and Identification of the Responsibility centres directly in scope (Access and Core) and involvement of supporting departments.
- 3) Grouping of the cost of support functions and allocation of these costs to Access and Core to compute the final network costs elements to be allocated to Technical products. These network cost elements are stated in figure 9 as Access network and Core network.



- 4) Allocation of the Access and Core network costs to the Technical products in scope, which represent the cost for accessing the network as wholesale customer. The Technical products in scope are Access line, ATV, DTV and Broadband.

The next section will describe in-depth all building blocks of the Opex cost allocation flow.

6.1. Cost allocation flow - Opex

6.1.1. Introduction

In order to ensure a complete and accurate cost base, it is crucial to explain the first moment a cost item is registered into the accounting system. Telenet registers every individual invoice, Opex and Capex, according to a unique Accounting Flex Key (AFK) which is a set of dimensions used in the accounting team and across the company to determine the correct mapping towards cost nature, legal entities, departments, products, etc. and is the baseline for all reporting tracks across (and outside) the company.

This AFK key was fully revised and brought in line with future reporting needs at the back of the launch of the updated ERP system (Oracle Fusion), which went live as per January 2018. The individual items, that are not already connected during the PO/PR process, are linked during the invoice imputation process using twelve different attributes (the different number of segments in the AFK), such as entity, G/L account and Responsibility centre. These attributes need to be completed or by the business owner at the moment of the creation of the PR or by the Accounts Payable team at the moment the invoice is booked (in the absence of a PO). The two segments, which are important for the cost allocation flow, are G/L accounts and Responsibility centres and will be described in detail in the next section. The other segments are used for various internal and external reporting purposes but are not relevant for the cost allocation model.

The figure below illustrates the different segments used.

	Segment 1	Segment 2	Segment 3	Segment 4	Segment 5	Segment 6	Segment 7	Segment 8	Segment 9	Segment 10	Segment 11	Segment 12
LG	Entity	Account	Responsibility Center	Product	Capex Category	Counterparty	Movement Code	Reporting Code	Business Line	Classification Code	Spare 1	Spare 2
TELENET (Fusion)	5 Common: 5 Local: 0	9 Common: 6 Local: 3	5 Common: 2 Local: 3	6 Common: 3 Local: 3	4 Common: 4 Local: 0	5 Common: 5 Local: 0	4 Common: 4 Local: 0	6 Common: 6 Local: 0	3 Common: 0 Local: 3	4 Common: 0 Local: 4	4	4

Figure 10: AFK key description, source: AFK Training documentation

Example: When an invoice for a maintenance cost is received by the Accounting Department (Accounts Payable team), the costs will be posted on a G/L account and functional Responsibility centre. The functional Responsibility centre will indicate the department, for which the costs were incurred, e.g. Access and Core. The PO/PR process flow, described in section 4.1, includes a review process by controllers, business owners and other stakeholders to align on the use of the correct AFK.



Figure 11 displays the setup of this matrix data view. It visualises the assignment of cost items from G/L accounts to Responsibility centres. There are two ways to assign costs items, the direct assignment at imputation of the invoice and an allocation or split of the cost item into the several Responsibility centres. This process is also linked to the creation of a PO/PR (section 4.1) as this is relevant for the majority of the Telenet spend. This is important, since it represents the first cost allocation step and ensures a correct cost base of the cost allocation model. Further details on this allocation step will be explained in section 6.1.6.

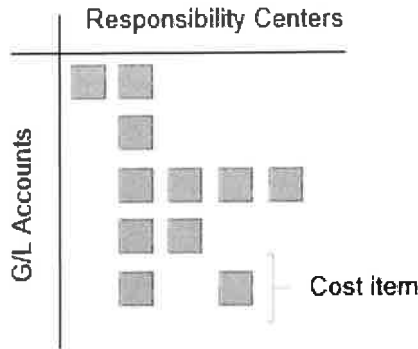

Figure 11: G/L Accounts assigned to Responsibility centres (source: created by author)

The next section will describe the relevant General ledger accounts in detail, which act as starting point of the cost allocation model.

6.1.2. General ledger accounts

The General ledger (G/L) represents the bookkeeping of a company’s financial data using a structure of G/L accounts. The General ledger records each financial transaction that takes place during the life of an operating company and therefore holds account information that is needed to prepare the company’s financial statements. As stated in figure 12 below, Telenet’s transactional data is structured by type into the Balance sheet or in the P&L accounts using a numerical system.

USGAAP

Balance sheet	1 = Assets
	2 = Liabilities
	3 = Equity
P&L	4 = Revenue
	5 = Direct Cost
	6 = } Indirect Cost
	7 = } Indirect Cost
	8 = Other
	80 = Other OPEX below OCF
	85 = Other income & expense
	86 = Income taxes
87 = Earnings/Loss attributable to NCI	

Figure 12: G/L Accounts structure – US GAAP based (Source: Telenet AFK Structure)



Every G/L account has a unique number based on their nature of content of spend or income. In this section, we will only describe direct and indirect costs since they form the cost base for the allocation model. The table below provides an overview of all high level direct and indirect cost accounts of Telenet and how these G/L accounts are assigned towards Responsibility centres.

Account Level	Description	Allocation/assignment to Responsibility centre
ACC_500000000	Total Direct Costs	
ACC_510000000	Direct Cost – Interconnect/roaming	Direct
ACC_520000000	Total Direct Cost - Other	Direct
ACC_530000000	Programming And Broadcast Ops Direct Cost	Direct
ACC_599999000	Total Indirect Costs	
ACC_600000000	Total Staff Related Cost	FTE per department
ACC_650000000	Travel & Entertainment	Direct
ACC_660000000	Total Facilities Related Expenses	Energy costs based on electricity meter, all other Direct
ACC_670000000	Telecommunications	Direct
ACC_680000000	Office Supplies & Equipment Lease	Direct
ACC_690000000	Company Vehicles	Direct
ACC_700000000	Total Network Related Expenses	Leased lines based on split rent B2B/network, all other Direct
ACC_710000000	IT Related Expenses	Direct
ACC_720000000	Audit & Legal	Direct
ACC_730000000	Professional Services	Direct
ACC_740000000	Bank Fees	Direct
ACC_750000000	Bad Debt & Collection	Direct
ACC_760000000	Total Capitalised Labour & Expenses	Capitalised labour based on FTE per department, other Direct
ACC_770000000	Outsourced Call Centre	Direct
ACC_780000000	Marketing And Advertising	Direct
ACC_790000000	Total – Other Expenses	Direct

Table 4: Global AFK (Source: Telenet)

This table forms the starting cost base, in which irrelevant G/L Accounts need to be excluded to achieve a relevant cost base that is in line with the scope of Coax network regulation.

Relevant cost base

The direct costs of Telenet are grouped under Cost of Goods Sold (COGS) into following categories:

- Interconnect/roaming Direct Cost
- Total Direct Cost - Other
- Programming and Broadcast Ops Direct Cost

All grouped costs, in the mentioned categories are excluded from the Cost Allocation Model as they refer to costs directly linked to the end service provided to the customers. Telenet does not sell content related or any other commercial products to its wholesale customers.

This implies that the cost base in scope is narrowed down by excluding all ACC_500000000 accounts (Total Direct Costs). The accounts that are taken into account are the following:

Account Level	Description	Allocation/assignment to Responsibility centre
ACC_599999000	Total Indirect Costs	
ACC_600000000	Total Staff Related Cost	FTE per department



Account Level	Description	Allocation/assignment to Responsibility centre
ACC_650000000	Travel & Entertainment	Direct
ACC_660000000	Total Facilities Related Expenses	Energy costs based on electricity meter, all other Direct
ACC_670000000	Telecommunications	Direct
ACC_680000000	Office Supplies & Equipment Lease	Direct
ACC_690000000	Company Vehicles	Direct
ACC_700000000	Total Network Related Expenses	Leased lines based on split rent B2B/network, all other Direct
ACC_710000000	IT Related Expenses	Direct
ACC_720000000	Audit & Legal	Direct
ACC_730000000	Professional Services	Direct
ACC_740000000	Bank Fees	Direct
ACC_750000000	Bad Debt & Collection	Direct
ACC_760000000	Total Capitalised Labour & Expenses	Capitalised labour based on FTE per department, other Direct
ACC_770000000	Outsourced Call Centre	Direct
ACC_780000000	Marketing And Advertising	Direct
ACC_790000000	Total – Other Expenses	Direct

Table 5: relevant Opex cost base (Source: Global AFK)

The causal link towards technical products is achieved from the functional Responsibility centres described in the following section. Every cost of the G/L accounts is assigned to Responsibility centres as described in the introduction in section 6.1.

6.1.3. Responsibility centres

One of the major building blocks of the cost allocation model deals with Responsibility centres (RSP). The Responsibility centres follow the organisational structure of Telenet Group Holding. Responsibility centres are used in internal management reporting for various cost analysis and are used to roll-up towards the Liberty Global reporting and analysis requirements.

Responsibility centres roll up from the lowest level (Level 4) via a parent level (Level 3) to (for example) a Network cost (Level 2) before rolling up to the department level (Level 1). This roll-up of RSPs is based on a one-to-one or many-to-one relationship as stated below in table 6. Section 6.1.4 will elaborate on the Network costs. The scope of this document is focused on wholesale and Coax network, and therefore, as indicated in chapter 3, the Responsibility centres rolling up into the network-related departments from Technology & Innovation (Access and Core) are included in the table below:

- 32 Responsibility centres at the lowest level roll up into Access
- 15 Responsibility centres at the lowest level roll up into Core

RSP Level 4	Description	RSP Level 3	Description	RSP Level 2	Description
RSP_62101	TIO Staff	RSP_P62100	Access Networks - Mgt	RSP_P62000	Access Networks
RSP_62301	OLD Access	RSP_P62300	Access Network Engineering	RSP_P62000	Access Networks
RSP_62302	OLD Capacity Mgmt & Technology Office	RSP_P62300	Access Network Engineering	RSP_P62000	Access Networks
RSP_62304	OLD Technology	RSP_P62300	Access Network Engineering	RSP_P62000	Access Networks

Confidential Inter



	Office Engineering				
RSP_62305	TIO Access & Capacity Engeneering	RSP_P62300	Access Network Engineering	RSP_P62000	Access Networks
RSP_62401	TB Service Delivery : 3rd party access & project costs	RSP_P62400	Access Network Expansion	RSP_P62000	Access Networks
RSP_62601	TIO BNT	RSP_P62600	Access Network Optimization	RSP_P62000	Access Networks
RSP_62801	OLD Pulsar Project	RSP_P62800	Access Network Deployment Lead	RSP_P62000	Access Networks
RSP_62802	Field Partnership Managment	RSP_P62800	Access Network Deployment Lead	RSP_P62000	Access Networks
RSP_62803	Fiber & Backhaul Solutions	RSP_P62800	Access Network Deployment Lead	RSP_P62000	Access Networks
RSP_62804	OLD Projects Delivery	RSP_P62800	Access Network Deployment Lead	RSP_P62000	Access Networks
RSP_62805	OLD Build Delivery	RSP_P62800	Access Network Deployment Lead	RSP_P62000	Access Networks
RSP_62806	Intake & Support	RSP_P62800	Access Network Deployment Lead	RSP_P62000	Access Networks
RSP_62807	OLD Network Information & Quality Delivery	RSP_P62800	Access Network Deployment Lead	RSP_P62000	Access Networks
RSP_62808	OLD Coax Build - East Infra	RSP_P62800	Access Network Deployment Lead	RSP_P62000	Access Networks
RSP_62809	OLD Capacity Programs	RSP_P62800	Access Network Deployment Lead	RSP_P62000	Access Networks
RSP_62810	OLD XXL Delivery	RSP_P62800	Access Network Deployment Lead	RSP_P62000	Access Networks
RSP_62811	New Build Fix	RSP_P62800	Access Network Deployment Lead	RSP_P62000	Access Networks
RSP_62812	Demand & Planning	RSP_P62800	Access Network Deployment Lead	RSP_P62000	Access Networks
RSP_62813	Coax & Infrastructure Solutions	RSP_P62800	Access Network Deployment Lead	RSP_P62000	Access Networks
RSP_62814	B2B & Special Coverage	RSP_P62800	Access Network Deployment Lead	RSP_P62000	Access Networks
RSP_62815	Replacements, Moves & Lifecycle	RSP_P62800	Access Network Deployment Lead	RSP_P62000	Access Networks
RSP_62816	Site Coordination	RSP_P62800	Access Network Deployment Lead	RSP_P62000	Access Networks



RSP_62817	Backhaul & Node Segmentation	RSP_P62800	Access Network Deployment Lead	RSP_P62000	Access Networks
RSP_62818	XXL	RSP_P62800	Access Network Deployment Lead	RSP_P62000	Access Networks
RSP_62901	Central Adjustment COS	RSP_P62900	Access Network Field Operations	RSP_P62000	Access Networks
RSP_62902	IGS	RSP_P62900	Access Network Field Operations	RSP_P62000	Access Networks
RSP_62903	Field Force	RSP_P62900	Access Network Field Operations	RSP_P62000	Access Networks
RSP_62904	Network Planning & Admin	RSP_P62900	Access Network Field Operations	RSP_P62000	Access Networks
RSP_62905	T-Cel	RSP_P62900	Access Network Field Operations	RSP_P62000	Access Networks
RSP_62906	HFC Field Engineers	RSP_P62900	Access Network Field Operations	RSP_P62000	Access Networks
RSP_62907	HFC Improvements & Logistics	RSP_P62900	Access Network Field Operations	RSP_P62000	Access Networks
RSP_63201	TIO Core Infrastructure	RSP_P63200	Core Strategy & Engineering	RSP_P63000	Core N&O
RSP_63401	Inside Plant	RSP_P63400	Tech Site Strat Engineering & Build	RSP_P63000	Core N&O
RSP_63402	Data Center Infrastructure	RSP_P63400	Tech Site Strat Engineering & Build	RSP_P63000	Core N&O
RSP_63501	OLD Network Infra	RSP_P63500	Network & Business Planning	RSP_P63000	Core N&O
RSP_63601	TIO Service Operations Center	RSP_P63600	Operations	RSP_P63000	Core N&O
RSP_63602	Data Network Operations	RSP_P63600	Operations	RSP_P63000	Core N&O
RSP_63603	Access Support	RSP_P63600	Operations	RSP_P63000	Core N&O
RSP_63604	Tv Support	RSP_P63600	Operations	RSP_P63000	Core N&O
RSP_63605	Mobile & Fixed Voice Operations	RSP_P63600	Operations	RSP_P63000	Core N&O
RSP_63606	TIO Cloud & Platform	RSP_P63600	Operations	RSP_P63000	Core N&O
RSP_63607	OLD Coax Build - Admin Support	RSP_P63600	Operations	RSP_P63000	Core N&O
RSP_63608	OLD IT Network & Security	RSP_P63600	Operations	RSP_P63000	Core N&O
RSP_63609	OLD IT Programs - IT Hosting & Cloud	RSP_P63600	Operations	RSP_P63000	Core N&O



RSP_63610	TIO Engineering	RSP_P63600	Operations	RSP_P63000	Core N&O
RSP_63611	Network & Security	RSP_P63600	Operations	RSP_P63000	Core N&O
RSP_63901	OLD T&I PLANNING	RSP_P63900	Core Programs	RSP_P63000	Core N&O

Table 6: Responsibility centre Roll-up (Source: Metadata_v2.2022.12)

6.1.4. Network costs

The cost grouping in the Network cost categories is the final step before allocation towards the Technical products. Within the area of the Coax regulation, the Network cost categories Access network and Core network are considered in scope, including a reasonable cost allocation of the Support costs functions:

- **Access Networks**

The Access Networks Responsibility centre group contains all plan-, design- and build (if not capitalisable) activities related to the Access Network. This Responsibility centre is related to the TIO Plan, Engineering and Build departments discussed in chapter 3. The Access Network includes all infrastructure from the Access edge platforms (CMTS, CCAP, EQAM, OLT, xDSL) to the demarcation point at or inside the households. This includes all fiber and coaxial infrastructure elements.

From the cost category Access Network "RSP_62401 – TB Service Delivery: 3rd party access – project costs" is excluded from the calculation scope as this RSP covers activities directly linked to B2B services which are out of scope of the HFC network regulatory framework.

- **Core**

Activities related to the operation of all non-mobile platforms and infrastructure core are assigned to the Core Responsibility centre. This means all network monitoring, operations support and service assurance for Residential, B2B and IT are included in Core. In addition, also all plan-, design- and build activities related to the data centre environment as well as the (inter-)national backbones are part of Core.

From the cost category Core network following three responsibility centers are treated differently in the cost allocation to technical products:

- "RSP_63601 TIO Service Operations Center" is allocated based on a specific deep dive as a substantial part of these resources are allocated to B2B services which are out of scope of the HFC regulatory framework.
- "RSP_63604 TV Support" is 100% allocated to DTV.
- "RSP_63605 Mobile & Fixed Voice Operations" is excluded from the calculation scope as this RSP covers activities directly linked to telephony services which are out of scope of the HFC network regulatory framework.

- **Support**

The costs assigned to the Responsibility centres of Access and Core are the main pillars of the cost base of the allocation model. However, since a cost allocation model needs to be based on a full end-to-end cost approach, also indirectly related costs such as overhead costs need to be allocated to the Technical components. The supporting departments of wholesale activities were already described in detail in chapter 3. The Responsibility centres for these supporting activities are stated in table 7 below:



Level 1	Level 2	Level 3	Description
Support	Commercial	RSP_23511	Regulated Wholesale
	Management & Support	RSP_32000	Internal and External Comms
	Management & Support	RSP_34000	Legal and Legal/Business Affairs
	Management & Support	RSP_36000	People
	Management & Support	RSP_37000	Management
	Finance	RSP_41000	Property & Facilities
	Finance	RSP_42000	Procurement
	Finance	RSP_43000	Control & Capital Allocation (incl. Financial Planning)
	Finance	RSP_44000	Accounting & Reporting (incl. Financial Systems)
	Finance	RSP_45000	Risk & Compliance Tot
	Finance	RSP_46000	Treasury
	Finance	RSP_47000	IR & Corp responsibility
	Finance	RSP_49000	Tax Tot
	Technology and Innovation	RSP_P61000	IT
	Technology and Innovation	RSP_P65000	Supply Chain
Technology and Innovation	RSP_P66000	Technology	

Table 7: Support Functions Responsibility centres (Source:Metadata_v2.2022.12)

As stated above, the Network cost categories are used for the further allocation towards the Technical products. These two categories are a combination of the above-mentioned Responsibility Centre families. The detailed allocation of support cost is described in section 6.1.5.2.

- **Access network:**

Access network reflects the previously mentioned Responsibility centre Access including the allocated costs from the supporting functions related to the Coax network.

- **Core network:**

Core network reflects the previously mentioned Responsibility centre Core including the allocated costs from the supporting functions related to the Telenet core infrastructure.

The following section describes the Technical products, which represent the wholesale access and to which the needed cost base will be allocated. For cost allocation purposes, it is key to determine the correct and applicable Technical products, for which prices will need to be defined.

Telenet offers a range of voice, data, broadband internet products and services that are tailored to the size and needs of the customer. Telenet needs to document the cost allocation, cost calculation and price setting of the products towards their wholesale customers. These customers will pay a fee for using the Telenet fixed Coax network but offer their own commercial products to their client base.

Consequently, we will not describe all the commercial product offerings of Telenet as they are not part of the regulated HFC network scope.

The complete series of Telenet's Technical products consist out of Analogue TV (ATV), Digital TV (DTV), Set-top box (STB), Network Personal Video Recorder (nPVR) (as of April 2019), Fixed Telephony, Broadband, Access line, Mobile and other commercial offers such as Entertainment products (Play, Play More, Sport, etc.) or B2B solutions (Security, Hosting, etc.).



However, the STB, nPVR (as of April 2019), Telephony, Mobile and other offers (Entertainment, B2B, etc.) are not related to the HFC network regulatory framework and are therefore excluded from the scope of this cost calculation/allocation. The products that are related to the use of the regulated HFC network will be described below:

- **Access Line**

The Access Line is the user network that connects the wholesale customer (e.g. Orange) to the particular network of the service provider (Telenet) and the carrier network. The wholesale customer will pay a fee to Telenet for having access to the network. This product offering is key as it links the Technical products from the wholesale customer to the Coax network of Telenet and is the base cost for all further commercial offerings.

- **Television**

The services provided by Telenet to its wholesale customers include the supply of television signals using the Telenet network, including related installations, maintenance and repair. The technical product consists of two components:

- **Digital TV**

- Digital TV (DTV) provides third-party operations with access to the digital television platform. DTV is the transmission of television signals using digital encoding in contrast to ATV, in which the video and audio are carried by analogue signals.

- **Analogue TV:**

- Analogue television is the original television technology that uses analogue signals to transmit video and audio content. While broadcasting the brightness, colours and sounds are represented by rapid variations of either the amplitude, frequency or phase of the signal.

- **Broadband:**

Telenet offers access to third-party operators to a bitstream offer of broadband internet access. High-speed internet access is always available and faster than traditional analogue services. It is offered in four different forms: Digital Subscriber Line (DSL), fibre-optic, cable and satellite.

6.1.5. Allocation keys

The following chapter describes the allocation methods used in the Telenet wholesale cost allocation model. The allocation methods are displayed as coloured arrows in the previously shown figure 9 the end-to-end cost allocation flow. There are three different types of allocation methods considered:

1. Cost assignment from G/L accounts to functional Responsibility centres.
2. Allocation of costs from supporting functions towards Access and Core network costs.
3. Final allocation of Access network and Core network costs towards the Technical products.

6.1.5.1. *Cost assignment from G/L accounts to functional Responsibility centres*

The assignment of cost items from G/L accounts to functional Responsibility centres is the first allocation step of the cost allocation model. This step is important since it ensures that all relevant cost items are



correctly reflected in the cost base. Manual interferences from input procedures are linked to Telenet's underlying overall control framework.

There are two methods to assign a cost item towards Responsibility centres, direct assignment (one G/L account-to-one RSP) and allocation (one G/L account-to-many RSP):

- **Direct assignment (one-to-one):** as described earlier in the introduction of this section, supplier invoices are booked according to a unique AFK. This procedure can be described as one-to-one assignment of costs towards a functional Responsibility centre during the imputation process of an invoice. This direct assignment is linked to the PO/PR flow process as this process handles the majority of the costs and is related to the Telenet internal control process.
- **Allocation (one-to-many):** some of the G/L account lines, which are treated differently from the above-mentioned direct assignment, can also be allocated to different RSPs since the costs are not received via an external invoice, but input is booked based on underlying tools or systems. The relevant G/L account lines are as follows:
 - **Staff-related costs:** the procedure to register staff related costs was already previously described in section 4.2. In general, staff-related costs are posted by the Payroll Financial Controller on Responsibility centres according to the department, which the employee works for, based on the underlying detailed information obtained via the payroll agency (Attentia) and based on the FTE-mapping (based on metadata maintained and reviewed by respectively Employee/HR and business controller).
 - **Capitalised labour:** the capitalisation of personnel costs is shifting cost items in scope of network regulation from the Opex allocation flow to the Capex allocation flow. Thus, the Opex costs booked on a specific Responsibility centre are reduced, while the Capex costs per depreciation line are increased. This will lead to a difference in the final cost allocation due to different allocation keys used in the respective flows. The allocation key for capitalisation is the %-rate of work performed, which was already described in section 5.1. The allocation keys towards Technical products are described in paragraph 6.1.6.1 and section 6.2.2.
 - **Energy costs:** energy costs for Fixed Network, such as nodes and headends, are accounted based on a fixed consumption rate received via invoices. However, energy costs for sites are based on real-time electricity meters (included in a separate database called VOLT).
 - **Leased lines:** leased lines are allocated to a B2B Telenet Responsibility centre if the leased line is used for Business-to-Business (B2B) customers. The remaining leased lines are related to the fiber network and posted under an Access network Responsibility centre. These lines and costs are managed via a separate database called YETI.

The table below illustrates information from the full overview of all G/L accounts and the used information for the allocation. On the left side of the table, the G/L accounts are displayed. On the right side of the table, there is the following key information given for every G/L account: Allocation method, description of allocation key used, owner and source.



Cost Accounts (G/L)	Account description	Allocation/assignment	Key description	Owner	Source
ACC_610200001	Payroll - Other - Addition provision anniversary and seniority bonus (63)	Allocation key	Org structure	Telenet Financial controlling	Essbas
ACC_610200002	Payroll - Other - Anniversary bonus	Allocation key	Org structure	Telenet Financial controlling	Essbas
ACC_610200003	Payroll - Other - Reverse provision anniversary and seniority bonus (63)	Allocation key	Org structure	Telenet Financial controlling	Essbas
ACC_610200004	Payroll - Other - Seniority bonus	Allocation key	Org structure	Telenet Financial controlling	Essbas
ACC_610200005	Payroll - Other - Social security accrual performance shares	Allocation key	Org structure	Telenet Financial controlling	Essbas
ACC_610200006	Payroll - Other - Social security anniversary bonus	Allocation key	Org structure	Telenet Financial controlling	Essbas
ACC_610200007	Payroll - Other - social security bonuses	Allocation key	Org structure	Telenet Financial controlling	Essbas
ACC_610200008	Payroll - Other - social security contract breach	Allocation key	Org structure	Telenet Financial controlling	Essbas

Table 8: G/L Accounts to Responsibility centres (Source: created by author)



6.1.5.2. Allocation from Support to Access & Core network costs

The second allocation step describes the allocation of support costs towards Access & Core network costs. This step is necessary to ensure a full cost allocation model and to allocate the costs according to their nature, which is the support of the Access and Core departments.

The allocation keys used in this cost allocation step are described schematically in table 9 below, and provides following key information for every Support Responsibility centre in scope: allocation key, and description of allocation key.

RSP Level 2	Level 2 description	Allocation Key	Key description
23000	Other Commercial	Regulated Wholesale Department	2022 actual figures for Regulated Wholesale Department directly to Access Network
34000	Legal and Legal/Business Affairs	Spend in scope (Opex) vs Total spend	Opex in scope (Access & Core) compared to total spend
36000	People	Spend in scope (Opex) vs Total spend	Opex in scope (Access & Core) compared to total spend
37000	Management	Spend in scope (Opex) vs Total spend	Opex in scope (Access & Core) compared to total spend
41000	Property & Facilities	Spend in scope (Opex) vs Total spend	Opex in scope (Access & Core) compared to total spend
42000	Procurement	Spend in scope (Opex) vs Total spend	Opex in scope (Access & Core) compared to total spend
43000	Control & Capital Allocation (incl. Financial Planning)	Spend in scope (Opex) vs Total spend	Opex in scope (Access & Core) compared to total spend
44000	Accounting & Reporting (incl. Financial Systems)	Spend in scope (Opex) vs Total spend	Opex in scope (Access & Core) compared to total spend
45000	Risk & Compliance	Spend in scope (Opex) vs Total spend	Opex in scope (Access & Core) compared to total spend
46000	Treasury	Spend in scope (Opex) vs Total spend	Opex in scope (Access & Core) compared to total spend
48000	Group Consolidation & Technical Accounting	Spend in scope (Opex) vs Total spend	Opex in scope (Access & Core) compared to total spend
49000	Tax	Spend in scope (Opex) vs Total spend	Opex in scope (Access & Core) compared to total spend
61000	IT	Bottom-up identification of IT Services and Business Insights & Data	Bottom-up identification of IT Services and Business Insights & Data
65000	Supply Chain	Spend in scope (Opex) vs Total spend	Opex in scope (Access & Core) compared to total spend
66000	Technology	Workload % Fixed network	Percentage of workload on Fixed network applied on RSP's in scope directly to Core network

Table 9: Allocation Keys for Support Cost categories (Source: Oracle AfK_v8)

Allocation key overview

The paragraphs below will further describe the allocation keys, which are re-evaluated every year, in detail:

- **Bottom-up identification of IT Services and Business Insights & Data**

IT Services and Business Insight Data Services relevant to support fixed network activities are identified and listed bottom-up. The 2022 actual cost base of these services including an IT overhead markup of 7% is directly allocated to Fixed Access Network.

- **Regulated wholesale**

As described in section 6.1.4, the Regulated Wholesale department is part of the Other Commercial unit dealing with wholesale client interactions and activities. Currently, nine employees are fulltime working within the Regulated Wholesale department. The costs of this department are directly assigned to Access networks.



- **Spend in scope (Opex) compared to total spend**

The Opex by function view in the Capital Allocation Report (CAR) provides an overview of how much of the Opex costs can be attributed to Access and Core compared to the total indirect costs. This information is provided in the detailed CAR Report.

- **% Revenue Fixed versus Mobile**

In order to split the support costs of Access and Core into fixed and mobile network, the percentage revenue split is applied.

6.1.6. Technical products

6.1.6.1. Allocation from Access & Core to Technical products

This section describes how the enriched Access and Core network costs will be allocated to the Technical products which are in scope using defined allocation keys. This is the final allocation step in the Opex cost allocation flow. As described previously in figure 9 the end-to-end cost allocation flow; there are two allocation steps to be performed:

1. Split of Access and Core Network costs into Mobile costs and fixed Access/fixed Core costs.
2. Allocation of fixed Access and fixed Core costs towards the Technical products.

The first allocation step splits the Access and Core Network costs into mobile and fixed network costs. Only the fixed network costs are taken into consideration for the final cost allocation towards Technical products. In order to identify the part of fixed network costs, a bottom-up Responsibility center review is performed by Business Controlling. The bottom-up analysis applies for every RSP in scope according to its nature a % - share based either on an operational allocation key (# of RGU fixed/mobile) or technical allocation key (% - share capex fixed / mobile network). The calculated amount of mobile network costs is then excluded from the cost base of the final cost allocation.

The second allocation step uses the remaining cost base, the fixed Access costs and fixed Core costs, and allocates these costs to the Technical products according to technical characteristics of the HFC network described in chapter 2.

Allocation key overview

- **Coax Bandwidth – Fixed Products**

The Coax Bandwidth – Fixed Products key depends on the spectrum usage of each of the Technical products. The configuration and measurement of the usage per Technical product takes place in the Access part of the HFC network comprising all Coax network cables installed in the street.

The data is sourced out of the network configuration of the spectrum. Within the spectrum, there are a number of frequencies used to determine the different occupation per product. However, usages only change if Telenet applies a different configuration, performed by the Telenet Engineering team on a half-yearly basis, or adds new frequencies.

The %-bandwidth usage of ATV and DTV is summed up into the Technical product Access line. This special assignment follows the logic that the access line to households was built to deliver TV services (first



analogue services, later on in digital). This has been considered as the base costs for a household to get access to the Coax network.

- **IP Capacity – Fixed Products**

The IP Capacity allocation key is based on the data usage by the different Technical products in the Core part of the HFC network described in chapter 2. Analogue to the Allocation key Coax Bandwidth – fixed products, this allocation key is applied to the remaining fixed Core costs after separation of mobile cost components using the % capex fixed vs mobile as key.

The IP Capacity – Fixed Products key is calculated by using a weighted average calculation of IP capacity used upstream and downstream per product. Downstream represents the download speed from Telenet to the end customer, while upstream signifies the uploading from a customer to Telenet.

The key is used to allocate the Core Network cost base to the Technical products offering and calculated according to following formula (example for Broadband):

$$\frac{[(IP\ Capacity\ Downstream\ \%_{BB} * Downstream\ (Gbps)_{Total}) + (IP\ Capacity\ upstream\ \%_{BB} * Upstream\ (Gbps)_{Total})]}{(Downstream\ (Gbps)_{Total} + Upstream\ (Gbps)_{Total})}$$

The allocation percentages towards the other Technical products are calculated similarly as the formula stated above.

As described in the formula above, the key is calculated by using a weighted average of the IP Capacity Downstream multiplied by the total Gigabits per second (Gbps) used in the downstream flow and the IP Capacity Upstream multiplied by the total Gbps used in the Upstream flow divided by the total Down- and Upstream flows per product.

The data used to calculate the Allocation key is based on the usage in Gbps at daily peak usage by residential customers and business customers. The Deep Package Inspection (DPI) system is the source system for this data. It is a tool that enables Telenet to track customer traffic and measures how much traffic was generated at a certain point in time. DPI allows Telenet to investigate which products, data or systems that customers are using.

- **IP Capacity – All Products**

The IP Capacity – All Products key represents the consolidated view of the first cost assignment from Core network costs to fixed and mobile Core costs and applying then the weighted IP capacity key for the allocation towards the Technical products.

6.2. Cost allocation flow – CAPEX

The following chapter describes the second part of the cost allocation model, which is the allocation of the asset costs towards the Technical products. The purpose of this chapter is to:

1. Explain the full cost allocation flow of asset costs.
2. Describe the different components of asset costs and their calculation.
3. Give an overview of the allocation keys used and their causal relation to the Technical products.



Asset costs are the main cost elements related to the HFC network. The Allocation flow is highlighted in the red frame in the overall cost allocation model described in figure 13.

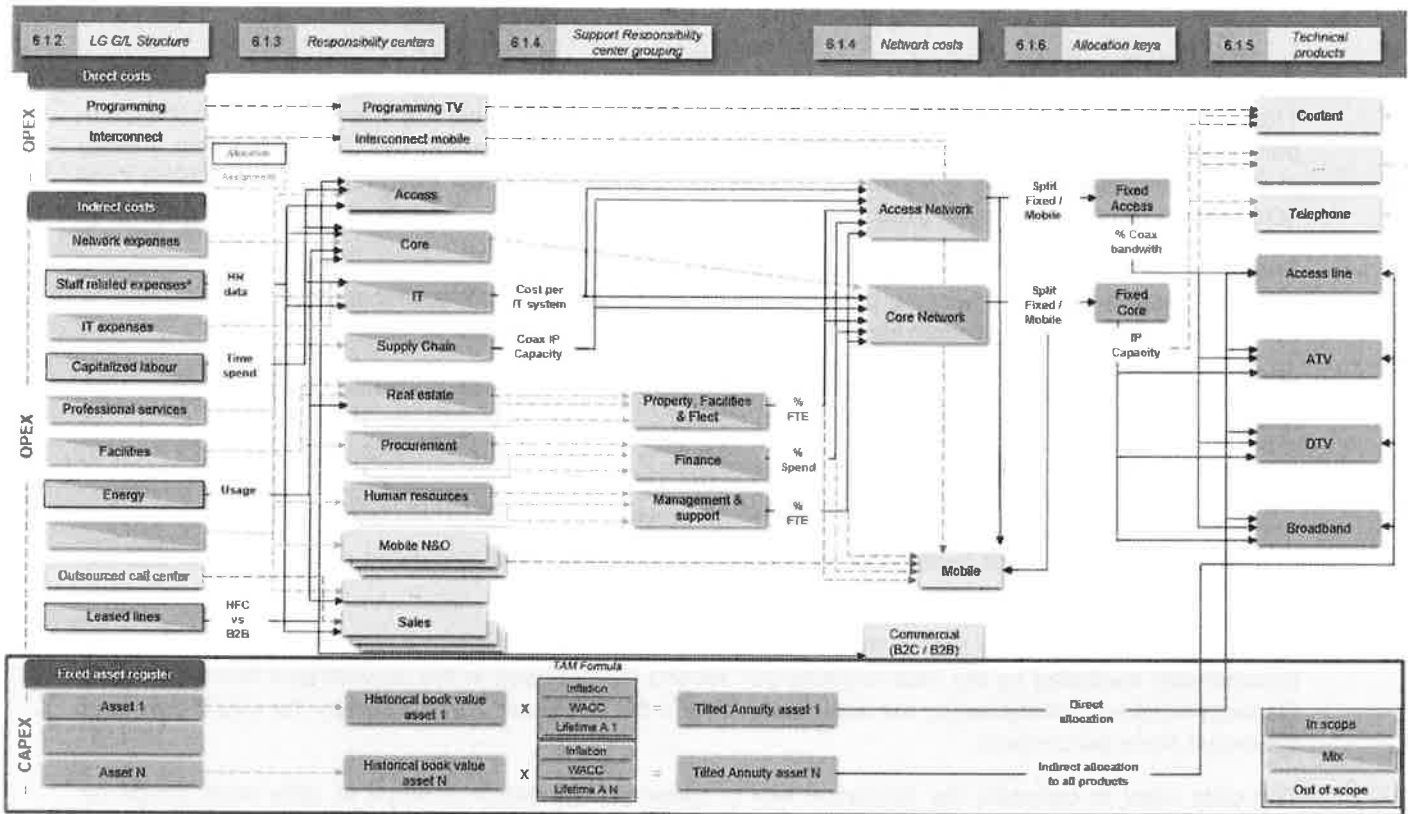

Figure 13: End-to-End Cost allocation flow (Source: created by author)

Telenet defined a cost allocation model, which was implemented to compare retail and wholesale prices per commercial offering. The method to calculate the asset costs in the cost allocation model is based on the Tilted Annuity Method (TAM), which is described in detail in the next section. The asset costs used for allocation to Technical products include operational and financial cost components represented by the initial purchase price and its lifetime, the inflation rate over the years and the Cost of Capital.

The next section focuses on the different components of the asset cost described above.



6.2.1. Tilted Annuity Depreciation (TAM)

The Tilted Annuity Depreciation method, introduced in chapter 5, is a depreciation method that can be applied in a Current Cost Accounting model. The annuity approach calculates an amount per period that replaces the depreciation and the capital charge and is appropriate if the price of an asset is expected to change over time. The tilted annuity charge changes between years at the same rate as the price of the asset is expected to change. This results in declining annual charges if prices are expected to fall over time.

The computation of the asset costs in the cost allocation model is estimated according to following formula:

$$\text{Asset cost}_{G/L \text{ account}} = \text{Initial asset cost}_{G/L \text{ account}} * \frac{WACC - Inflation}{\left(1 - \frac{1 + Inflation}{1 + WACC}\right)^{\text{Asset lifetime}}}$$

The formula contains four main components: the initial investment and respective lifetime, the inflation rate and the Weighted average Cost of Capital (wacc). The paragraphs below will further elaborate on these elements.

- **Initial investment and lifetime**

Over the years, Telenet has invested strongly in assets to build its fixed network. These assets are assumed to generate revenues over their lifetime. The initial investment value and lifetime of every asset is stored in the Fixed Asset Register, which can be extracted out of Essbase.

In the TAM method, the Asset lifetime refers to the expected period that a new asset will be used. The aspect of future new technologies is taken into account because new technologies replace the current assets. As part of the financial reporting cycle, the useful life of an asset is regularly reviewed by Business Controlling and the Engineering department.

- **Inflation rate**

The inflation rate represents the rate of price changes over time. The information was extracted from the worldwide inflation database of 'Inflation.eu', which features an overview of the historic Belgian Consumer Price Index (CPI). This database contains all information on current and historical inflation rates by country and year.

The applied inflation rate for the annuity calculation of an asset needs to have the same time horizon than the used years of the respective asset. As an example, if an asset is already in use for ten years, the inflation rate also needs to reflect the price changes of these ten years. The cost allocation model uses for this purpose the CAGR of the inflation rates over the respective years an individual asset is in use.

- **Weighted average Cost of Capital (WACC):**

The weighted average Cost of Capital (WACC) is a central element in all Corporate Finance and valuation calculations. The purpose of the WACC is to determine the cost of each part of the company's capital structure based on the proportion of equity and debt. Both components have a cost to the company. The company pays a fixed rate of interest on its debt and pays dividends in the form of cash to equity holders. The wacc is used in financial modelling as the discount rate to calculate the net present value of a company.

As shown below, the WACC is calculated as following:

$$\text{wacc} = (c_e * E/(E+D)) + ((c_d * D)/(E+D))$$

Where:



- E = market value of the firm's equity (market cap)
- D = market value of the firm's debt
- $E/(E+D)$ = percentage of capital that is equity
- $D/(E+D)$ = percentage of capital that is debt
- c_e = cost of equity (required rate of return)
- c_d = after-tax cost of debt (yield to maturity on existing debt)

For the model the WACC of the BIPT has been used.

6.2.2. Allocation from Asset costs to Technical products

This section describes the allocation from the identified and relevant Asset costs to the Technical products ATV, DTV, Access and Broadband. The cost allocation of the Opex cost base was already described in section 6.1 of this document.

As introduced in the previous section, the Telenet depreciation accounts can be extracted out of Oracle Fusion. Every asset cost in the Fixed Asset register contains a depreciation expense account. These depreciation lines are individually, based on their nature, categorised as either out of scope (e.g. CPE, mobile), directly or indirectly related to the Technical products. This exercise is done by Business Controlling in accordance with the Telenet Business Engineering department. The table below illustrates the described exercise and list all relevant depreciation lines within the regulated HFC network scope and defined Allocation keys.

Account	Description	Allocation Key	Allocation Method
821800003	Other Depreciation - buildings	General overhead (Buildings)	FTE network allocation
821800004	Other Depreciation - buildings head-end	Coax infrastructure	Direct to access
821800005	Other Depreciation - common lease	Coax infrastructure	Direct to access
821800006	Other Depreciation - Central office DTV	Central office related to Digital TV	Direct to DTV
821800007	Other Depreciation - Central office hardware	General overhead (Equipment)	FTE network allocation
821800009	Other Depreciation - company vehicles	General overhead	FTE network allocation
821800013	Other Depreciation - CPE hotspots	Hotspots related to Broadband	Direct to BB
821800014	Other Depreciation - CPE installation and connection	Coax infrastructure	NA - no costs
821800016	Other Depreciation - furnishings in leased buildings	General overhead (Buildings)	FTE network allocation
821800017	Other Depreciation - headend equipment	Coax infrastructure	Direct to access
821800019	Other Depreciation - headend spare	Coax infrastructure	Direct to access
821800020	Other Depreciation - HFC	HFC infrastructure	Network Key - Fixed products
821800022	Other Depreciation - lease buildings (US-GAAP)	General overhead (Buildings)	FTE network allocation
821800025	Other Depreciation - NU and filters CPE	HFC network before demarcation	BB + TEL + DTV
821800026	Other Depreciation - office & IT equipment	General overhead (Equipment)	FTE network allocation
821800031	Other Depreciation - switching / routing	HFC network before demarcation	BB + TEL + DTV
821800032	Other Depreciation - human	Depreciation human	FTE network allocation
821800034	Other Depreciation - transmission	Core infrastructure	IP Capacity - All Products
821800035	Other Depreciation - transmission Fiber	Core infrastructure	IP Capacity - All Products
821800037	Other Depreciation - formation expenses, capital increases	General overhead (Capital increases)	NA - no costs
821800043	Other Depreciation - unfavorable CIP inventory differences (85)	Capitalized CPE & capitalized non-CPE	NA - no costs
821800044	Other Depreciation - capital grants (75)	General overhead (Capital subsidies)	FTE network allocation
821800045	Other Depreciation - capital grants IDTV (75)	General overhead (Capital subsidies IDTV)	Direct to IDTV
821800048	Other Depreciation - cars & leasehold cars	General overhead	FTE network allocation
822100001	Customer Lists - 15y	Coax infrastructure	Direct to access
822300004	Other Amortization - Chentale fee (15y)	Coax infrastructure	Direct to access
822300005	Other Amortization - Chentale fee Pica	Coax infrastructure	Direct to access
822300006	Other Amortization - consolidation differences	Goowill related to takeover of Coax companies	Direct to access
822300007	Other Amortization - development	General overhead (IT)	IT Depreciation Key
822300012	Other Amortization - third party software	General overhead (IT)	IT Depreciation Key
822300014	Other Amortization - weights third parties	Coax infrastructure	Direct to access
822300009	Other Amortization - licenses	General overhead (IT)	FTE network allocation
821800008	Other Depreciation - central office TSO	Not Applicable	NA - no costs
821800011	Other Depreciation - corrections on depreciations	Not Applicable	NA - no costs
821800012	Other Depreciation - CPE business	Not Applicable	NA - no costs

Table 10: Depreciation accounts and allocation keys (Source: created by author)

As described previously, the direct or indirect allocation to a technical product is the first allocation step. For the indirectly related depreciation lines, an allocation key needs to be applied. This key is determined based on a causality principle stating the relationship between the assets included in the depreciation line and the Technical products.



When an asset is registered, it is posted to a Telenet project as described in section 5.1 and stored in the PA module. These projects can be grouped into Telenet programs to obtain already a first clustering, as indicated in table 11 below.

Asset number	Asset description	Project number	Project name	Project program
2003179	OAP + SI + ALL + 4243	1119075	IT DW_CVP I	P0000184 - Darwin
1291736	IP Edge Routers	1076149	ACE_CCAP CASA	P0000604 - Access & Capacity
2025371	300000001074049 + 300000001074057 + ALL + 25090	1095892	IT Opex E-Dev	P0000570 - IT Delivery
1315191	CANON Lease	1069142	IK Non-Cash Capex HFC 2012	P0000726 - BAU Fixed - IGS
2006973	300000001074049 + 300000001074057 + ALL + 6546	1082868	IT ERP Fusion Applications	P0000109 - Fusion
1330159	IP Edge Routers	1076149	ACE_CCAP CASA	P0000604 - Access & Capacity
1328402	Central Computing Hardware	1086923	COE_IP Network Growth	P0000627 - Network Infra
2003178	300000001074049 + 300000001074057 + ALL + 4242	1119075	IT DW_CVP I	P0000184 - Darwin
1313724	CANON Lease	1059888	IK Non-Cash Capex HFC 2011	P0000726 - BAU Fixed - IGS
2018603	OSCM + MISC_INV + 100000001060313+ISSUE + 19535	2000585	In Home Connectivity	P0000158 - IHC
1300537	Aug- 14+CPE.IDTV.35008+Activation.A	1077430	CPE STB Accounting	P0000028 - Rental Install

Table 11: Extract of projects grouping into programs (Source: Telenet Controlling)

Based on the description and content of these programs, Business Controlling can determine which projects are related to the Coax network. Building on this, Business Controlling performed a quality check on the matching of projects to the depreciation expense accounts. As a result of this deep dive some costs are reclassified between depreciation expense accounts and their related defined allocation keys. In addition, the costs related to amortization of IT development (depr. acc. 822300007) and third party software (depr. acc. 822300012) are not considered in the asset cost in order to avoid doublecount as all IT services and Business Insight & Data services relevant to support fixed asset activities are identified and listed bottom-up and charged through directly to the fixed access network in opex (see 6.1.5.2). The allocation keys applied on the depreciation accounts are stated below:

Direct allocation keys

- **Direct to Access line**

Assets that are linked to the Coax network are directly allocated towards the Technical product Access line.

- **Direct to BB**

The Direct to BB allocation key follows the same approach as the Direct to Access key. Direct to BB assigns the full asset cost directly to the Broadband product, in this case, the instalment costs of hotspots/Wi-Fi equipment in the network.

- **Direct to DTV/Direct to iDTV**

This allocation key directly allocates the costs related to (interactive) Digital TV to the iDTV and DTV products respectively. Due to the direct relationship, the asset costs are 100% assigned to the product. Please note that the Technical product iDTV is not in scope of Coax network regulation.

- **Direct to other technical products**

In the same way some asset costs are 100% assigned to other products e.g. B2B products, voice fixed & mobile, VoD due to the direct relationship. Please note that these products are not in scope of Coax network regulation.



Indirect allocation keys

- **BB + TEL + DTV**

This allocation key assigns the respective asset costs towards Broadband, Telephone and Digital TV based on a weighted average calculation of the number of Revenue Generating Units (RGU) for Broadband, Telephone and Digital TV. The formula for identifying the allocation percentage of Broadband can be written as follows:

$$\frac{\#RGU'_{S_{BB}}}{Total \#RGU'_{S_{BB+Tel+DTV}}}$$

The formulas for Telephone and Digital TV follow the same approach as the formula, posted above.

- **IP Capacity – All Products**

The IP Capacity – All Products key is derived from the IP Capacity – Fixed products allocation key. This calculation is extensively described in the in section 6.1.6.

- **Network Key – All Products**

The determination of the Network Key – All products requires a two-way approach:

1. The total Telenet HFC network consists of Coax and Fiber cables, expressed in kilometres, for which the relation of one to the total is the first allocation key.
2. The second part of the Network Key – All Products calculation is a weighted average calculation applying the %-keys of step 1 on the IP Capacity – All Products and Coax Bandwidth – All Products allocation keys described earlier in section 6.1.6.

The Network Key – All Products for DTV is calculated as follows:

$$Network \ Key = \left(\frac{Coax}{Coax + Fiber} km * Coax \ Bandwidth - All \ Products_{e.g. \ DTV} \right) + \left(\frac{Fiber}{Coax + Fiber} km * IP \ Capacity - All \ Products_{e.g. \ DTV} \right)$$

The calculation of the allocation key towards the other Technical products follows the same approach as the formula above.

- **FTE Network allocation**

This allocation key is used for allocating general overhead costs, such as office & IT equipment or building-related overhead. The key allocates the asset costs based on the percentage share of direct headcount to each relevant asset cost driver in scope per Technical product.

6.3. Summary of Cost allocation flow

As described in the previous sections, the cost allocation model of Telenet consists of two independent allocation flows: Operational (Opex) and Capital expenditure (Capex). The total cost base provided in the G/L accounts, groupings to functional Responsibility centres and other input parameters were explained in the previous sections. Next to that, the applied allocation keys to assign the relevant costs towards the Technical products are explained in detail in the above text. This section describes the final step and the output of the cost allocation model.



The final step of the cost allocation model deals with the consolidation of the allocated costs of an individual Technical product in accordance to the offers which are in scope of regulation and which need to be offered to a wholesale customer. This calculation is done in the Telenet Wholesale Cost Allocation Model, which provides a cost per RGU for every Technical and Commercial offering. There are three steps that are required to obtain the final output:

- Calculation of costs per RGU
- Consolidation of Opex and Asset costs per Technical product
- Allocation of the Technical products to Commercial Offerings

Calculation of costs per RGU:

In order to achieve comparable costs to the current price-setting, the sum of the allocated cost elements needs to be divided by the number of Revenue Generating Units (RGU) for the respective Technical product in scope of regulation. The number of RGU can be extracted out of Essbase.

Consolidation of Opex and Asset costs per Technical product

The input costs per Revenue Generating Unit (RGU) for both the Opex and Capex flow are then consolidated per Technical product. These amounts are calculated by summing up the cost per RGU of the Opex and Capex flow.

Allocation of the Technical products to Commercial Offerings

An allocation matrix is required to determine the final pricing of the Commercial offerings. This allocation is performed based on causality between the source of the cost and the final commercial product offered to Telenet's clients. The matrix allocates the input costs of Access, ATV, DTV and BB to the applicable Commercial products BB, TV and BB + TV. Table 12 displays the allocation matrix that is used within the Telenet Cost Allocation model.

Allocation Matrix			
	BB	TV	BB+TV
Access	1	1	1
ATV		1	1
DTV		1	1
BB	1		1

Table 12: Allocation matrix (Source: created by author)

The cost for Access will be taken into account for every offered product, as described above in Table 12, because it represents the basis for having connection to the fixed network of Telenet. The Commercial offer of BB consists of the Technical products Access and BB, while the Commercial Offer TV represents Access, ATV and DTV. The Commercial Offering BB + TV is a combination of all Technical products in the matrix.



Chapter 7: Control mechanisms



7. Control mechanisms

The cost allocation model described in chapter 6 is based on the Liberty Global structure, which deviates from the Telenet structure in terms of using US GAAP figures and Responsibility centres. The following chapter provides guidance on:

1. Reconciling the US GAAP data of the cost model with the IFRS audited financial statements of Telenet.
2. Demonstrating the additional controls that ensure the correct mapping between both Responsibility centre structures.

7.1. Reconciliation of US GAAP vs IFRS figures

7.1.1. Opex reconciliation

The Cost allocation flow stated in figure 13 indicates the differences concerning the financial reporting frameworks between Telenet and Liberty Global. Telenet reports under the IFRS accounting standards, while the financial reporting practices of Liberty Global are based on US GAAP. The following section describes the bridge between both accounting standards for FY 2022.

This difference between the USGAAP and IFRS Opex is related to following accounting classifications:

- **Reclassification of social security**

This reclassification refers to a grouping of the social security costs to one account, which is necessary for reporting towards Liberty Global. Since it is a shift of costs within the personnel cost accounts, it has no impact on the financials and thus on the cost allocation model.

- **Reclassification of all Group insurance-related entries for CAR-reporting structure**

The Group insurance figures are reported by using multiple line items in IFRS, while these are grouped in US GAAP. Also, this reclassification does not change the cost base.

- **Contingent labour recovered**

This section refers to a mark-up invoiced by Telenet to Liberty Global for services that Telenet employees conduct for Liberty Global. Under US GAAP revenues and costs of these services are netted and shown below operating cash flow. This means that the costs are not part of the cost allocation model. In order to reconcile the figures to IFRS, the respective revenues and costs need to be included again.

- **Reclassification of AORTA interconnect cost (IP transit supplier)**

The AORTA interconnect costs are shown under IFRS as COGS, while US GAAP reclassifies the costs to OPEX.

- **GAAP difference between USGAAP and IFRS related to IFRS16**

While US GAAP will still show operational leases, the new IFRS 16 standard will identify and document all leasing agreements centrally as well as posting them as a finance lease. With this accounting treatment, the leasing expenses will be substituted with depreciation and interest expenses below OCF (adj. EBITDA).



7.1.2. Capex reconciliation

The main difference between US GAAP and IFRS in terms of Capex is the capitalisation of content linked to entertainment and movies on demand. This is, however, not in the scope of the Coax network regulation, leaving no difference for the BIPT asset scope in FY 2022.

7.2. Regular Controls by Liberty Global

Liberty Global performs on a regular basis controls on cost figures provided by Telenet as part of the monthly and quarterly closing process. The control mechanisms ensure that the cost base, which is used for the cost allocation model, is correctly composed and the mapping towards functional Responsibility Centers is accurately performed. The regular controls by Liberty Global can be divided into three different control types:

1. Controls during the monthly closing process:

Once the monthly closing process is finalized at the side of Telenet, and the Consolidation team confirms the submission into HFM, the Financial Planning & Reporting (FP&R) team starts reconciling the uploaded figures in the Capital Allocation Report (CAR) with the Essbase accounts. Therefore, the FP&R team provides a full bottom-up Essbase retrieval reconciling with the E2E CAR to the Business Controlling team. The reconciliation check is performed in-depth by analyzing the AFK Key bookings on General Ledger accounts and Responsibility Centers. The E2E CAR-report shows the figures on a more detailed level and includes different views, like e.g. the cost per functional departments. This check is important, since the cost per functional department from the CAR-report is used for the cost allocation of support costs as described previously in section 6.1.5.1.

FP&R gathers all differences between the actual and budget figures larger than 100.000 EUR and provides detailed narratives. These narratives are used to populate the CEO and CFO decks that are later reviewed in the month with LG. The preparation of these reports can be seen as additional control loop, which is performed every month.

The Controllers are in close contact with their counterparty in LG and needs to answer questions related to the Business performance and sometimes on mapping differences. If any mapping difference is identified, a review process is started to assess reporting impact. After assessment, an approval is requested internally to Accounting and Controlling responsible and later on to LG Capital allocation responsible for HFM submission of the changes.

LG provides on a monthly basis a detailed Data quality check on submitted figures across all operating companies. A detailed follow up on potential data quality issues are followed up by FP&R and discussed during the CFO review.

2. Controls during the Quarterly closing process:

The quarterly controls are performed in a more formalized way compared to the monthly controls. In frame of the quarterly closing procedure of Liberty Global, Telenet provides a cost template, called D9-Template, to the Headquarters of Liberty Global in Denver. This template contains all costs for every operational company within the Liberty Global Group in a specific structure and is analyzed up to the lowest level of detail before publicly disclosure of the 10-Q or 10-K statement. The reporting structure of the D-9 Template is different to the CAR-report and needs an additional mapping. Every deviation in a cost line of the template with a value higher than 1.000.000 EUR versus previous year needs a detailed explanation including the background of this deviation.



3. Controls in frame of the Sarbanes-Oxley Act (SOX):

Next to the controls described above there is an additional control mechanism based on the Sarbanes-Oxley Act requirements (SOX). The Sarbanes-Oxley Act was passed in 2002 by the Congress of the United States of America to protect shareholders and the general public investors from accounting errors and fraudulent practices in enterprises and to improve the accuracy of corporate disclosures. Telenet needs to comply with these Sarbanes Oxley Act requirements because Liberty Global is a US Company and the majority shareholder of Telenet.

The extended table of SOX control mechanisms includes the name and description of the control, whether Telenet relies on KPMG as Telenet auditor, the frequency of the control, the control method, the Telenet owner, the related IT applications, the level of judgement, changes in design, reliance on other controls and the risk of control failure.

All checks on the compliance to the SOX requirements are performed by Telenet itself except for D-10, on which Liberty Global performs a control at holding level. One of these oversights is the completeness and correctness of the financial statements in the previously described D-9 template. In this control mechanism, Telenet needs to answer whether the statements mentioned below are correct:

- Agree reclasses to supporting documents, as applicable, confirming reclass adjustments appear complete and accurate
- Confirm all HFM retrieve parameters of applicable tabs are correct for current period/entities/customs/accounts, etc.
- Confirm mathematical accuracy, including review of smartview formulas and check figures throughout
- Reconcile reclass amounts between bridge file, D-9 and revenue template to ensure reclasses are complete, accurate and consistent
- If any manual reclasses are needed in the D-9 and/or revenue template, manual reclasses have been agreed to supporting documents, as applicable, to ensure completeness and accuracy

The SOX-checklist also provides an overview of the responsible person for data preparation (FP&R department) and the person, who reviewed and validated the data upload (Business Controlling).

KPMG as auditor of Telenet performs also additional tests on particular SOX requirements. In some cases, KPMG will rely on the controls of the Telenet SOX team, which are reviewed afterwards by Liberty Global without testing themselves. In other events, KPMG will independently test a SOX control. Both Telenet and KPMG will perform the test without sharing the outcome with each other. However, if there would be a deficiency, both parties inform each other on this matter.

There are specific SOX controls, which are directly linked to the completeness of the cost base of the cost allocation model.

